

A CURA DELL'INSTALLATORE
 A CARE BY THE INSTALLER
 AUX SOINS DE L'INSTALLATEUR
 Eine Betreuung durch den INSTALLATEUR
 A CUIDADO POR EL INSTALADOR
 Um cuidado pelo instalador
 Een zorg door de INSTALLATEUR

COPYING OF THIS DOCUMENT, AND GIVING IT TO OTHERS AND THE USE OR COMMUNICATION OF THE CONTENTS THEREOF, ARE FORBIDDEN WITHOUT EXPRESS AUTHORITY. OFFENDERS ARE LIABLE TO THE PAYMENT OF DAMAGES. ALL RIGHTS ARE RESERVED IN THE EVENT OF THE GRANT OF A PATENT OF A MODEL OR DESIGN.

LINEA ALIMENTAZIONE :
 PREDISPORRE A MONTE
 UNA ADEGUATA PROTEZIONE
 CON INTERRUITTORE
 MAGNETOTERMICO
 DIFFERENZIALE

POWER LINE:
 PROVIDE A PROPER PROTECTION
 WITH DIFFERENTIAL
 MAGNETOTHERMAL SWITCH

LIGNE D' ALIMENTATION:
 PRÉPAREZ-VOUS À MONTER
 UNE PROTECTION ADEQUATE
 AVEC INTERRUPTEUR THERMIQUE
 DIFFERENTIEL

STROMLEITUNG:
 BEREITEN SIE VOR
 ANGEMESSENEN SCHUTZ
 MIT SCHALTER
 magnetothermischen
 DIFFERENTIAL

SUMINISTRO DE LINEA:
 PREPARARSE PARA MONTAR
 UN INTERRUPTOR DE CIRCUITO
 DE PROTECCIÓN ADECUADA

POWER LINE:
 FORNECER:
 uma protecção adequada
 com diferencial opção
 magnetothermal

POWER LINE:
 BIEDEN:
 EEN GOEDE BESCHERMING
 WITH DIFFERENTIEEL
 MAGNETOTHERMAL SCHAKELAAR

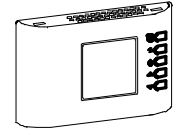

REVISIONS		DATE	18/06/2014		Unit 1ph+PCR+Hot-ColdCoil			=	
LAST REVISION DATE		COMMISS.	O.Meggiolaro					+	
SHEET STATUS		1	CHECK.			PCR 2014		SHEET 1	
SABIK VERSION		Ver. 16.00	APPROV.	SUBST.:	SUB. FOR:	ORIGIN:			2 N.S.

PROJECT: PCR_2014.sph
 FILE NAME
 TYPE:

COPYING OF THIS DOCUMENT, AND GIVING IT TO OTHERS AND THE USE OR COMMUNICATION OF THE CONTENTS THEREOF, ARE FORBIDDEN WITHOUT EXPRESS AUTHORITY. OFFENDERS ARE LIABLE TO THE PAYMENT OF DAMAGES. ALL RIGHTS ARE RESERVED IN THE EVENT OF THE GRANT OF A PATENT OF A MODEL OR DESIGN.
 PROJECT: PCR_2014.sph
 FILE NAME: PCR_2014.sph
 TYPE:

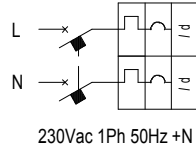

LINEA ALIMENTAZIONE :
 PREDISPORRE A MONTE
 UNA ADEGUATA PROTEZIONE
 CON INTERRUPTORE
 MAGNETOTERMICO
 DIFFERENZIALE

POWER LINE:
 PROVIDE A PROPER PROTECTION
 WITH DIFFERENTIAL
 MAGNETOTHERMAL SWITCH

LIGNE D' ALIMENTATION:
 PRÉPAREZ-VOUS À MONTER
 UNE PROTECTION ADEQUATE
 AVEC INTERRUPTEUR THERMIQUE
 DIFFERENTIEL

STROMLEITUNG:
 BEREITEN SIE VOR
 ANGEMESSENEN SCHUTZ
 MIT SCHALTER
 magnetothermischen
 DIFFERENTIAL

SUMINISTRO DE LINEA:
 PREPARARSE PARA MONTAR
 UN INTERRUPTOR DE CIRCUITO
 DE PROTECCIÓN ADECUADA

POWER LINE:
 FORNECER:
 uma protecção adequada
 com diferencial opção
 magnetothermal

POWER LINE:
 BIEDEN:
 EEN GOEDE BESCHERMING
 WITH DIFFERENTIEEL
 MAGNETOTHERMAL SCHAKELAAR

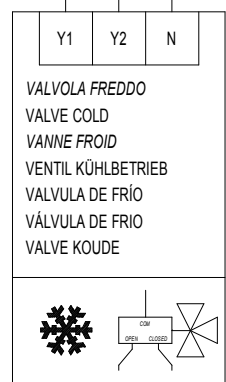
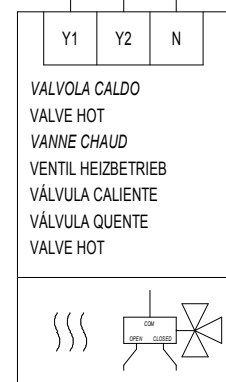
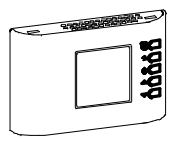
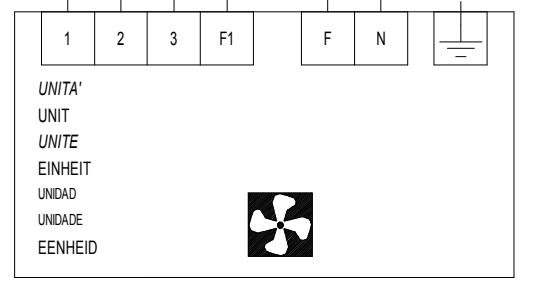
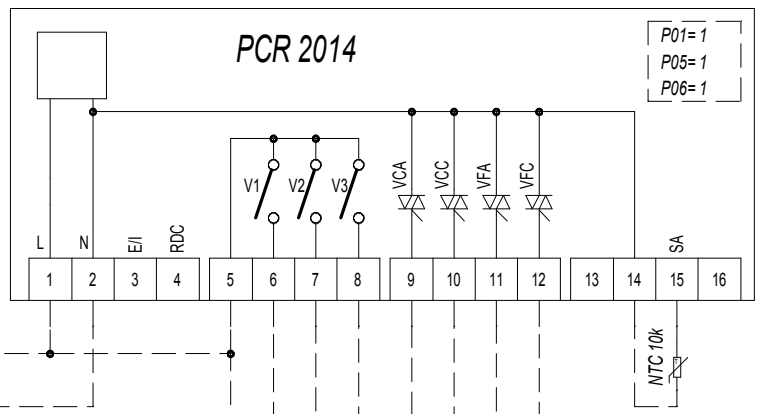

A CURA DELL'INSTALLATORE
 A CARE BY THE INSTALLER
 AUX SOINS DE L'INSTALLATEUR
 Eine Betreuung durch den INSTALLATEUR
 A CUIDADO POR EL INSTALADOR
 Um cuidado pelo instalador
 Een zorg door de INSTALLATEUR

REVISIONS	DATE	31/01/2014	Unit 1ph+PCR+HotCoil+ColdCoil					
LAST REVISION DATE	COMMISS.	OM						
SHEET STATUS	CHECK.				PCR 2014		SHEET	2
SABIK VERSION	APPROV.	Ver. 16.00	SUBST.:	SUB. FOR:	ORIGIN:		3	N.S.

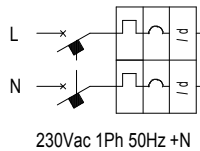

230Vac 1Ph 50Hz +N

LINEA ALIMENTAZIONE :
PREDISPORRE A MONTE
UNA ADEGUATA PROTEZIONE
CON INTERRUPTORE
MAGNETOTERMICO
DIFFERENZIALE

POWER LINE:
PROVIDE A PROPER PROTECTION
WITH DIFFERENTIAL
MAGNETOTHERMAL
SWITCH

LIGNE D' ALIMENTATION:
PRÉPAREZ-VOUS À MONTER
UNE PROTECTION ADEQUATE
AVEC INTERRUPTEUR THERMIQUE
DIFFÉRENTIEL

STROMLEITUNG:
BEREITEN SIE VOR
ANGEMESSENEN SCHUTZ
MIT SCHALTER
magnetothermischen
DIFFERENTIAL

SUMINISTRO DE LINEA:
PREPARARSE PARA MONTEAR
UN INTERRUPTOR DE CIRCUITO
DE PROTECCIÓN ADECUADA

POWER LINE:
FORNECER:
uma protecção adequada
com diferencial opção
magnetothermal

POWER LINE:
BIEDEN:
EEN GOEDE BESCHERMING
WITH DIFFERENTIEEL
MAGNETOTHERMAL SCHAKELAAR

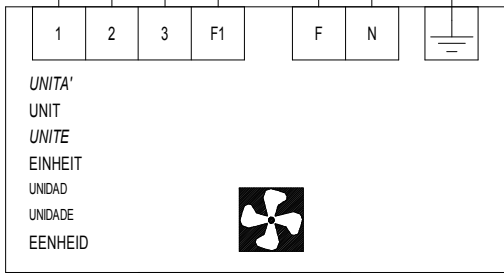
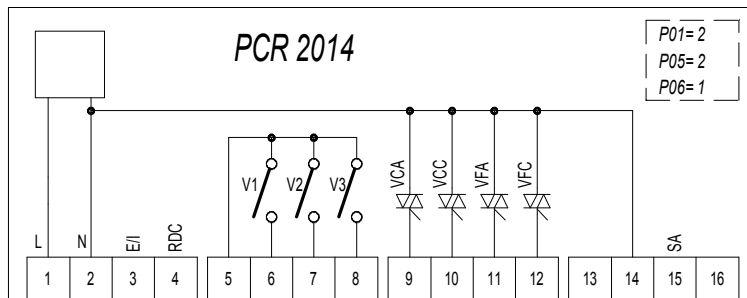
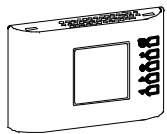

UNITA'
UNIT
UNITE
EINHEIT
UNIDAD
UNIDADE
EENHEID

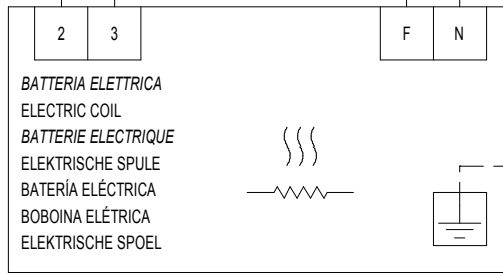

BATTERIA ELETTRICA
ELECTRIC COIL
BATTERIE ELECTRIQUE
ELEKTRISCHE SPULE
BATERIA ELÉCTRICA
BOBOINA ELÉTRICA
ELEKTRISCHE SPOEL

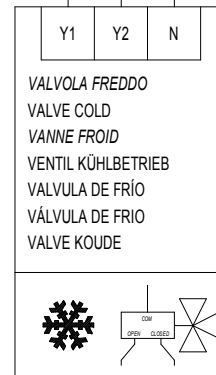

VALVOLA FREDDO
VALVE COLD
VANNE FROID
VENTIL KÜHLBETRIEB
VALVULA DE FRÍO
VÁLVULA DE FRIO
VALVE KOUDE

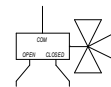

A CURA DELL'INSTALLATORE
A CARE BY THE INSTALLER
AUX SOINS DE L'INSTALLATEUR
Eine Betreuung durch den INSTALLATEUR
A CUIDADO POR EL INSTALADOR
Um cuidado pelo instalador
Een zorg door de INSTALLATEUR

COPYING OF THIS DOCUMENT, AND GIVING IT TO OTHERS AND THE USE OR COMMUNICATION OF THE CONTENTS THEREOF, ARE FORBIDDEN WITHOUT EXPRESS AUTHORITY. OFFENDERS ARE LIABLE TO THE PAYMENT OF DAMAGES. ALL RIGHTS ARE RESERVED IN THE EVENT OF THE GRANT OF A PATENT OF THE REGISTRATION OF A UTILITY MODEL OR DESIGN.

PROJECT: PCR_2014.snh
FILE NAME
TYPE:

REVISIONS		DATE	31/01/2014
LAST REVISION DATE		COMMISS.	OM
SHEET STATUS	0	CHECK.	
SABIK VERSION	Ver. 16.00	APPROV.	

SUBST.:		SUB. FOR:		ORIGIN:	
---------	--	-----------	--	---------	--

Unit 1ph+PCR+HEATER 1ph+ColdCoil

PCR 2014

SHEET 3
4 N.S.

A CURA DELL'INSTALLATORE
 A CARE BY THE INSTALLER
 AUX SOINS DE L'INSTALLATEUR
 Eine Betreuung durch den INSTALLATEUR
 A CUIDADO POR EL INSTALADOR
 Um cuidado pelo instalador
 Een zorg door de INSTALLATEUR

LINEA ALIMENTAZIONE :
 PREDISPORRE A MONTE
 UNA ADEGUATA PROTEZIONE
 CON INTERRUPTORE
 MAGNETOTERMICO
 DIFFERENZIALE

POWER LINE:
 PROVIDE A PROPER PROTECTION
 WITH DIFFERENTIAL
 MAGNETOTHERMAL SWITCH

LIGNE D' ALIMENTATION:
 PRÉPAREZ-VOUS À MONTER
 UNE PROTECTION ADEQUATE
 AVEC INTERRUPTEUR THERMIQUE
 DIFFERENTIEL

STROMLEITUNG:
 BEREITEN SIE VOR
 ANGEMESSENEN SCHUTZ
 MIT SCHALTER
 magnetothermischen
 DIFFERENTIAL

SUMINISTRO DE LINEA:
 PREPARARSE PARA MONTAR
 UN INTERRUPTOR DE CIRCUITO
 DE PROTECCIÓN ADECUADA

POWER LINE:
 FORNECER:
 uma protecção adequada
 com diferencial opção
 magnetothermal

POWER LINE:
 BIEDEN:
 EEN GOEDE BESCHERMING
 WITH DIFFERENTIEEL
 MAGNETOTHERMAL SCHAKELAAR

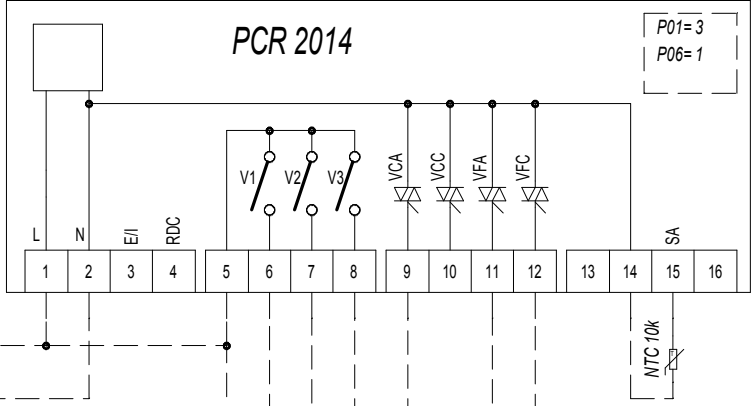
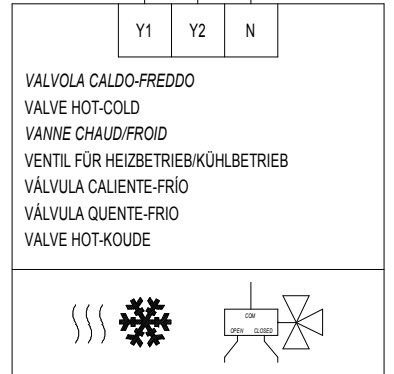
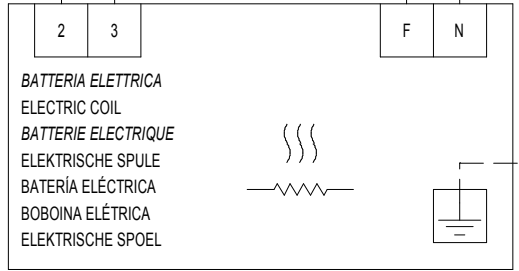
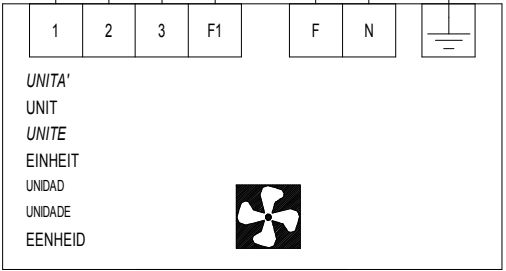
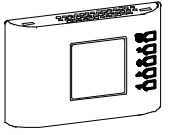

COPYING OF THIS DOCUMENT, AND GIVING IT TO OTHERS AND THE USE OR COMMUNICATION OF THE CONTENTS THEREOF, ARE FORBIDDEN WITHOUT EXPRESS AUTHORITY. OFFENDERS ARE LIABLE TO THE PAYMENT OF DAMAGES. ALL RIGHTS ARE RESERVED IN THE EVENT OF THE GRANT OF A PATENT OF THE REGISTRATION OF A UTILITY MODEL OR DESIGN

PROJECT: PCR_2014.sch
 FILE NAME: PCR_2014.sch
 TYPE:

REVISIONS		DATE	31/01/2014	Unit 1ph+PCR+HEATER 1ph+Hot-ColdCoil				
LAST REVISION DATE		COMMISS.	OM					
SHEET STATUS	0	CHECK.						
SABIK VERSION	Ver. 16.00	APPROV.		SUBST.:	SUB. FOR:	ORIGIN:	PCR 2014	SHEET 4 5 N.S.

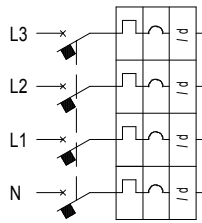

400Vac 3Ph+N 50Hz

LINEA ALIMENTAZIONE:
 PREDISPORRE A MONTE
 UNA ADEGUATA PROTEZIONE
 CON INTERRUITTORE
 MAGNETOTERMICO
 DIFFERENZIALE

POWER LINE:
 PROVIDE A PROPER PROTECTION
 WITH DIFFERENTIAL
 MAGNETOTHERMAL SWITCH

LIGNE D' ALIMENTATION:
 PRÉPAREZ-VOUS A MONTER
 UNE PROTECTION ADEQUATE
 AVEC INTERRUPTEUR THERMIQUE
 DIFFERENTIEL

STROMLEITUNG:
 BEREITEN SIE VOR
 ANGEMESSENEN SCHUTZ
 MIT SCHALTER
 magnetothermischen
 DIFFERENTIAL

SUMINISTRO DE LÍNEA:
 PREPARARSE PARA MONTAR
 UN INTERRUPTOR DE CIRCUITO
 DE PROTECCIÓN ADECUADA

POWER LINE:
 FORNECER:
 uma protecção adequada
 com diferencial opção
 magnetothermal

POWER LINE:
 BIEDEN:
 EEN GOEDE BESCHERMING
 WITH DIFFERENTIEEL
 MAGNETOTHERMAL SCHAKELAAR

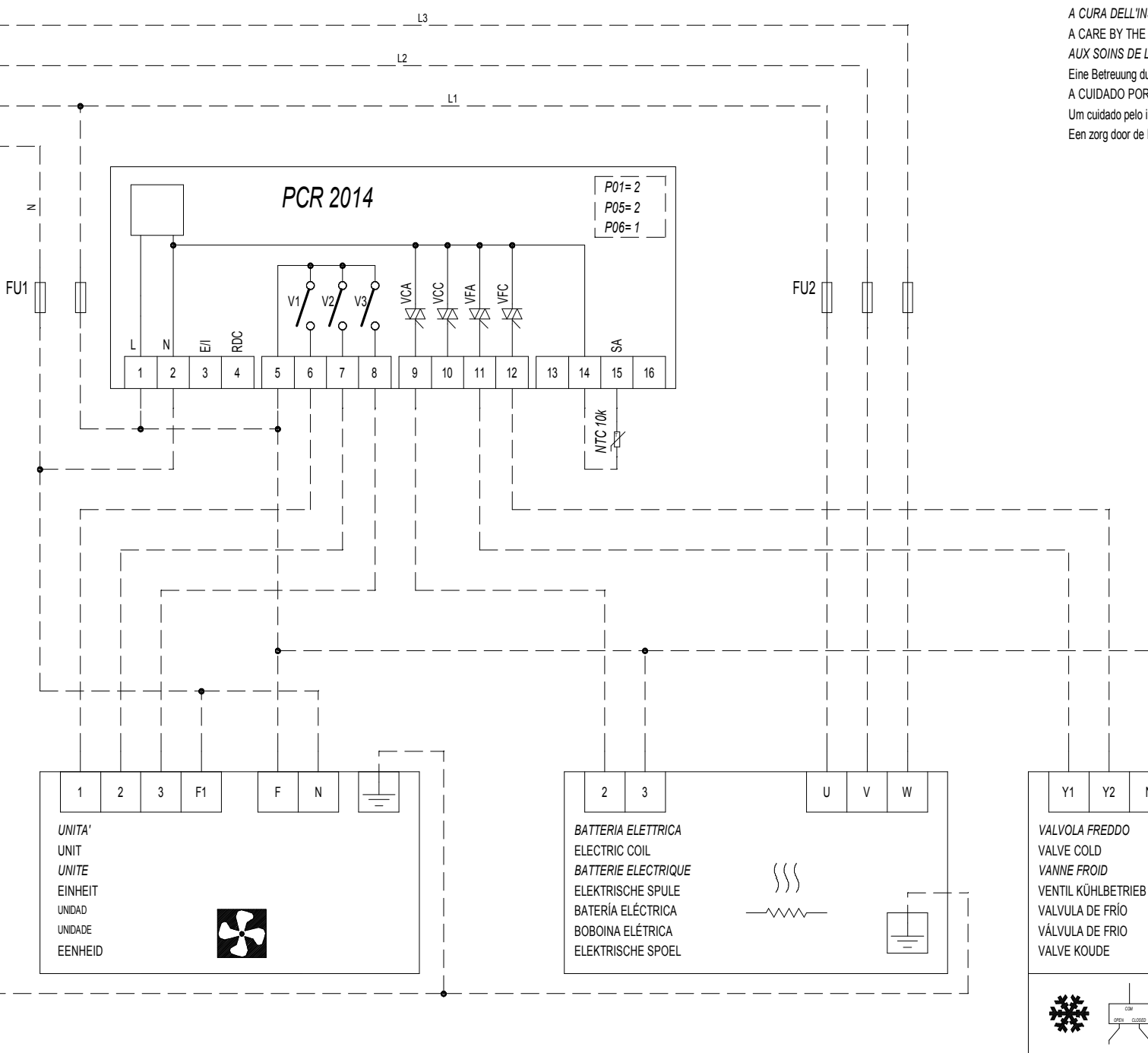
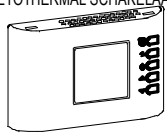

A CURA DELL'INSTALLATORE
A CARE BY THE INSTALLER
AUX SOINS DE L'INSTALLATEUR
 Eine Betreuung durch den INSTALLATEUR
 A CUIDADO POR EL INSTALADOR
 Um cuidado pelo instalador
 Een zorg door de INSTALLATEUR

COPYING OF THIS DOCUMENT, AND GIVING IT TO OTHERS AND THE USE OR COMMUNICATION
 OF THE CONTENTS THEREOF, ARE FORBIDDEN WITHOUT EXPRESS AUTHORITY. OFFENDERS
 ARE LIABLE TO THE PAYMENT OF DAMAGES. ALL RIGHTS ARE RESERVED IN THE EVENT
 OF THE GRANT OF A PATENT OF THE REGISTRATION OF A UTILITY MODEL OR DESIGN

PROJECT: PCR_2014.sph
 FILE NAME
 TYPE:

REVISIONS		DATE	31/01/2014																		
LAST REVISION DATE		COMMISS.	OM																		
SHEET STATUS	0	CHECK.																			
SABIK VERSION	Ver. 16.00	APPROV.		SUBST.:		SUB. FOR:		ORIGIN:													
														Unit 1ph+PCR+HEATER 3ph+ColdCoil							
																		PCR 2014		SHEET 5	
																		6		N.S.	

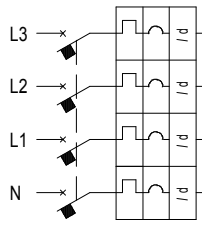

400Vac 3Ph+N 50Hz

LINEA ALIMENTAZIONE:
PREDISPORRE A MONTE
UNA ADEGUATA PROTEZIONE
CON INTERRUTTORE
MAGNETOTERMICO
DIFFERENZIALE

POWER LINE:
PROVIDE A PROPER PROTECTION
WITH DIFFERENTIAL
MAGNETOTHERMAL SWITCH

LIGNE D' ALIMENTATION:
PRÉPAREZ-VOUS A MONTER
UNE PROTECTION ADEQUATE
AVEC INTERRUPTEUR THERMIQUE
DIFFERENTIEL

STROMLEITUNG:
BEREITEN SIE VOR
ANGEMESSENEN SCHUTZ
MIT SCHALTER
magnetothermischen
DIFFERENTIAL

SUMINISTRO DE LÍNEA:
PREPARARSE PARA MONTAR
UN INTERRUPTOR DE CIRCUITO
DE PROTECCIÓN ADECUADA

POWER LINE:
FORNECER:
uma protecção adequada
com diferencial opção
magnetothermal

POWER LINE:
BIEDEN:
EEN GOEDE BESCHERMING
WITH DIFFERENTIEEL
MAGNETOTHERMAL SCHAKELAAR

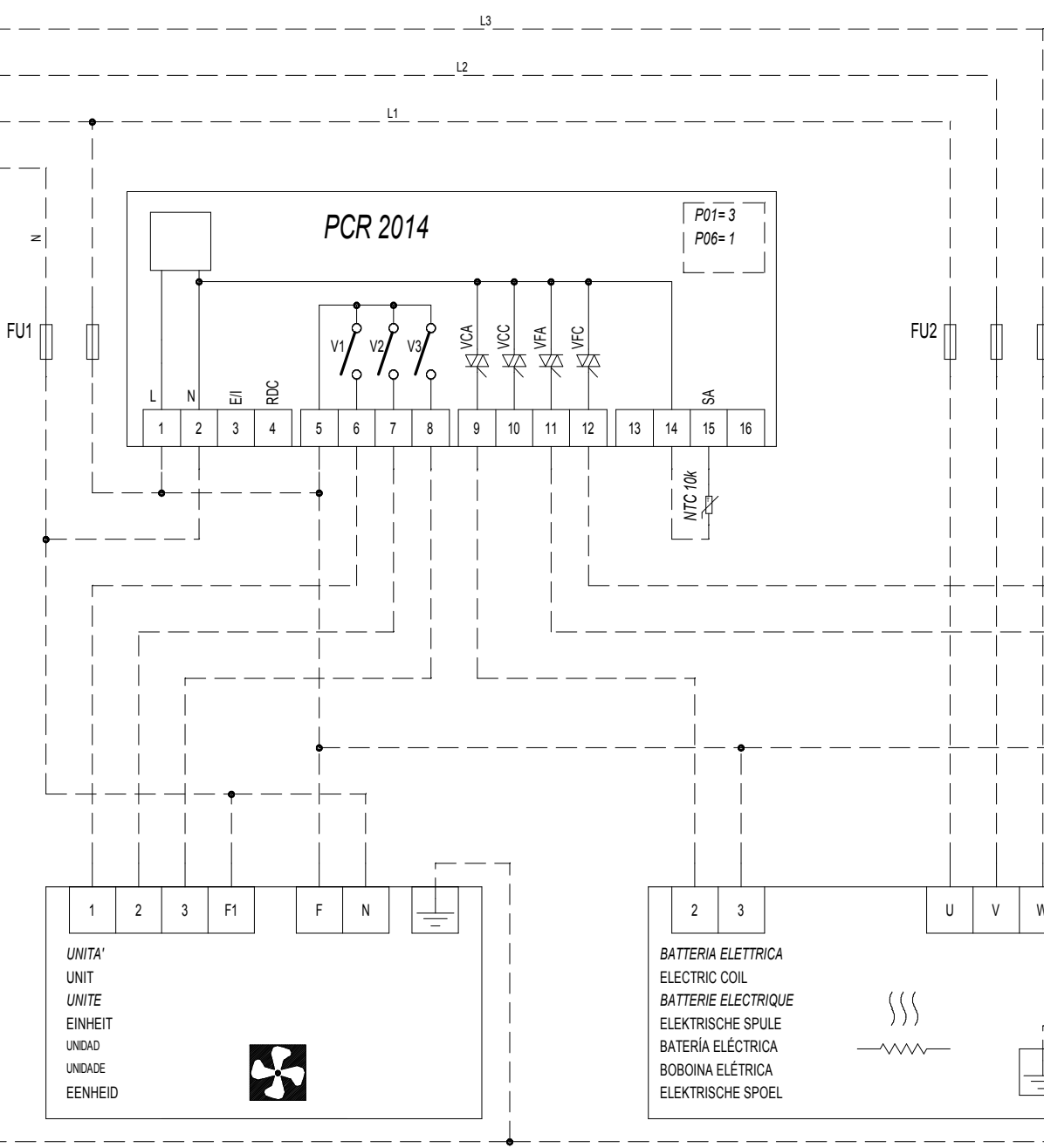
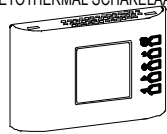

PCR 2014

P01=3
P06=1

A CURA DELL'INSTALLATORE
A CARE BY THE INSTALLER
AUX SOINS DE L'INSTALLATEUR
Eine Betreuung durch den INSTALLATEUR
A CUIDADO POR EL INSTALADOR
Um cuidado pelo instalador
Een zorg door de INSTALLATEUR

COPYING OF THIS DOCUMENT, AND GIVING IT TO OTHERS AND THE USE OR COMMUNICATION OF THE CONTENTS THEREOF, ARE FORBIDDEN WITHOUT EXPRESS AUTHORITY. OFFENDERS ARE LIABLE TO THE PAYMENT OF DAMAGES. ALL RIGHTS ARE RESERVED IN THE EVENT OF THE GRANT OF A PATENT OF THE REGISTRATION OF A UTILITY MODEL OR DESIGN

PROJECT: PCR_2014.sph
FILE NAME
TYPE:

REVISIONS		DATE	31/01/2014
LAST REVISION DATE		COMMISS.	OM
SHEET STATUS	0	CHECK.	
SABIK VERSION	Ver. 16.00	APPROV.	

SUBST.:		SUB. FOR:		ORIGIN:	
---------	--	-----------	--	---------	--

Unit 1ph+PCR+HEATER 3ph+Hot-ColdCoil		=	
		+	
PCR 2014			SHEET 6
			7 N.S.

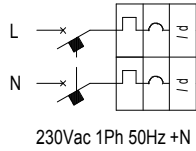

LINEA ALIMENTAZIONE :
 PREDISPORRE A MONTE
 UNA ADEGUATA PROTEZIONE
 CON INTERRUPTORE
 MAGNETOTERMICO
 DIFFERENZIALE

POWER LINE:
 PROVIDE A PROPER PROTECTION
 WITH DIFFERENTIAL
 MAGNETOTHERMAL SWITCH

LIGNE D' ALIMENTATION:
 PRÉPAREZ-VOUS À MONTER
 UNE PROTECTION ADEQUATE
 AVEC INTERRUPTEUR THERMIQUE
 DIFFERENTIEL

STROMLEITUNG:
 BEREITEN SIE VOR
 ANGEMESSENEN SCHUTZ
 MIT SCHALTER
 magnetothermischen
 DIFFERENTIAL

SUMINISTRO DE LINEA:
 PREPARARSE PARA MONTAR
 UN INTERRUPTOR DE CIRCUITO
 DE PROTECCIÓN ADECUADA

POWER LINE:
 FORNECER:
 uma protecção adequada
 com diferencial opção
 magnetothermal

POWER LINE:
 BIEDEN:
 EEN GOEDE BESCHERMING
 WITH DIFFERENTIEEL
 MAGNETOTHERMAL SCHAKELAAR

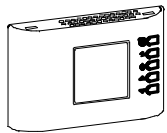

COPYING OF THIS DOCUMENT, AND GIVING IT TO OTHERS AND THE USE OR COMMUNICATION
 OF THE CONTENTS THEREOF, ARE FORBIDDEN WITHOUT EXPRESS AUTHORITY. OFFENDERS
 ARE LIABLE TO THE PAYMENT OF DAMAGES. ALL RIGHTS ARE RESERVED IN THE EVENT
 OF THE GRANT OF A PATENT OF A UTILITY MODEL OR DESIGN

PROJECT: PCB_2014.sch
 FILE NAME
 TYPE:

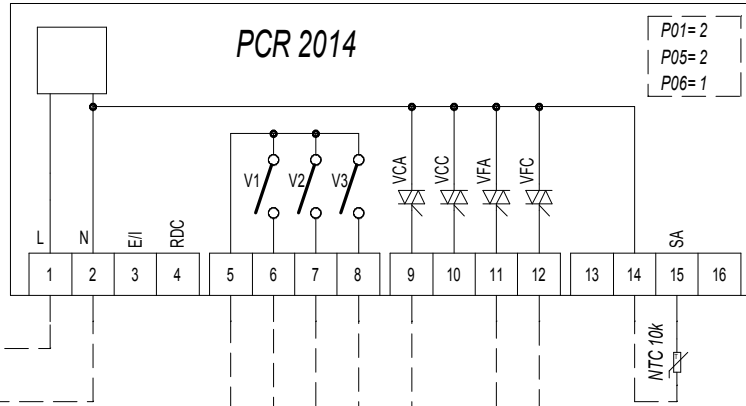

P01=2
 P05=2
 P06=1

A CURA DELL'INSTALLATORE
 A CARE BY THE INSTALLER
 AUX SOINS DE L'INSTALLATEUR
 Eine Betreuung durch den INSTALLATEUR
 A CUIDADO POR EL INSTALADOR
 Um cuidado pelo instalador
 Een zorg door de INSTALLATEUR

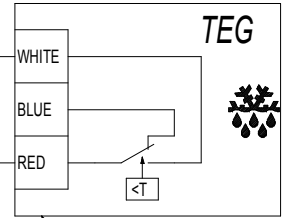

TERMOSTATO
 THERMOSTAT
 THERMOSTAT
 THERMOSTAT
 THERMOSTATO
 TERMÓSTATO
 THERMOSTAAT

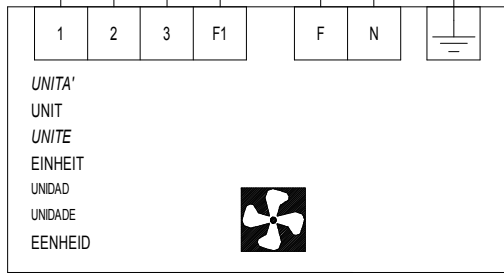

UNITA'
 UNIT
 UNITE
 EINHEIT
 UNIDAD
 UNIDADE
 EENHEID

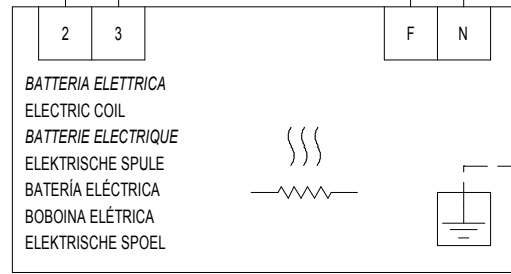

BATTERIA ELETTRICA
 ELECTRIC COIL
 BATTERIE ELECTRIQUE
 ELEKTRISCHE SPULE
 BATERÍA ELÉCTRICA
 BOBOINA ELÉTRICA
 ELEKTRISCHE SPOEL

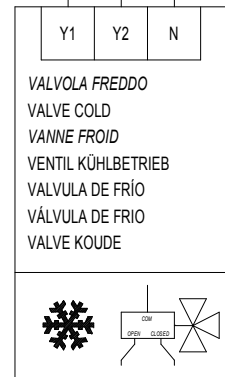

VALVOLA FREDDO
 VALVE COLD
 VANNE FROID
 VENTIL KÜHLBETRIEB
 VALVULA DE FRÍO
 VÁLVULA DE FRIO
 VALVE KOUDE

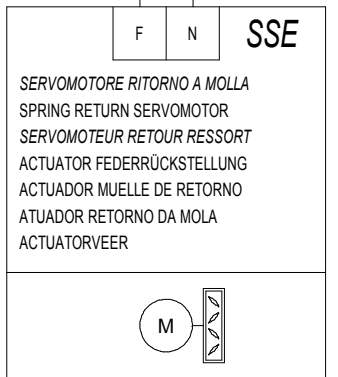

SERVOMOTORE RITORNO A MOLLA
 SPRING RETURN SERVMOTOR
 SERVOMOTEUR RETOUR RESSORT
 ACTUADOR FEDERRÜCKSTELLUNG
 ACTUADOR MUELLE DE RETORNO
 ATUADOR RETORNO DA MOLA
 ACTUATORVEER

REVISIONS		DATE	03/02/2014												
LAST REVISION DATE		COMMISS.	OM					Unit 1ph+PCR+HEATER 1ph+ColdCoil+Teg+SSE							
SHEET STATUS	1	CHECK.													
SABIK VERSION	Ver. 16.00	APPROV.		SUBST.:		SUB. FOR:		ORIGIN:				PCR 2014		SHEET	8
													9	N.S.	

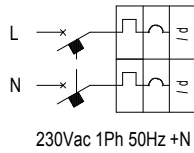

LINEA ALIMENTAZIONE :
 PREDISPORRE A MONTE
 UNA ADEGUATA PROTEZIONE
 CON INTERRUPTORE
 MAGNETOTERMICO
 DIFFERENZIALE

POWER LINE:
 PROVIDE A PROPER PROTECTION
 WITH DIFFERENTIAL
 MAGNETOTHERMAL SWITCH

LIGNE D' ALIMENTATION:
 PRÉPAREZ-VOUS À MONTER
 UNE PROTECTION ADEQUATE
 AVEC INTERRUPTEUR THERMIQUE
 DIFFERENTIEL

STROMLEITUNG:
 BEREITEN SIE VOR
 ANGEMESSENEN SCHUTZ
 MIT SCHALTER
 magnetothermischen
 DIFFERENTIAL

SUMINISTRO DE LINEA:
 PREPARARSE PARA MONTAR
 UN INTERRUPTOR DE CIRCUITO
 DE PROTECCIÓN ADECUADA

POWER LINE:
 FORNECER:
 uma protecção adequada
 com diferencial opção
 magnetothermal

POWER LINE:
 BIEDEN:
 EEN GOEDE BESCHERMING
 WITH DIFFERENTIEEL
 MAGNETOTHERMAL SCHAKELAAR

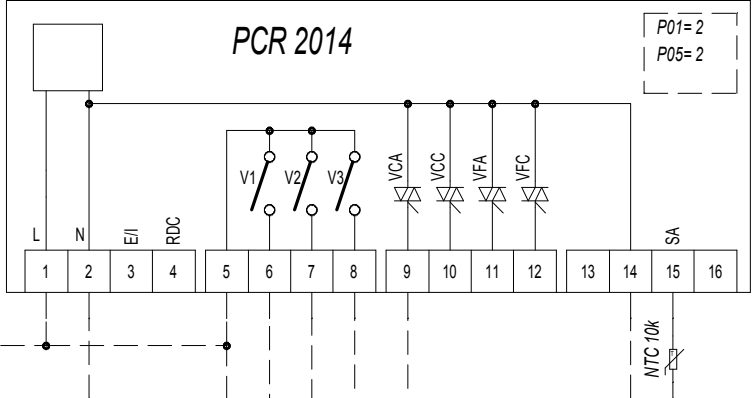
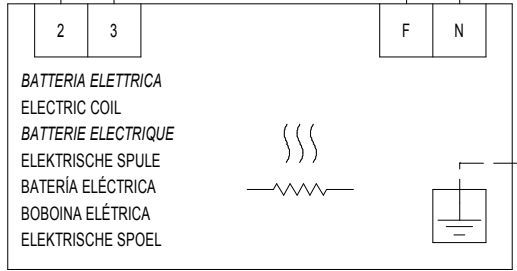
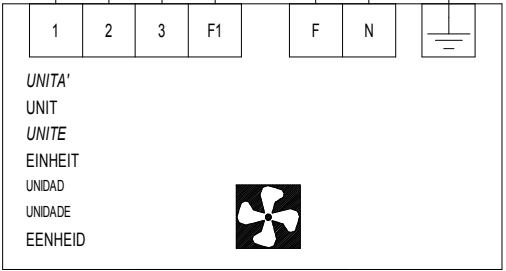
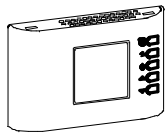

A CURA DELL'INSTALLATORE
 A CARE BY THE INSTALLER
 AUX SOINS DE L'INSTALLATEUR
 Eine Betreuung durch den INSTALLATEUR
 A CUIDADO POR EL INSTALADOR
 Um cuidado pelo instalador
 Een zorg door de INSTALLATEUR

COPYING OF THIS DOCUMENT, AND GIVING IT TO OTHERS AND THE USE OR COMMUNICATION OF THE CONTENTS THEREOF, ARE FORBIDDEN WITHOUT EXPRESS AUTHORITY. OFFENDERS ARE LIABLE TO THE PAYMENT OF DAMAGES. ALL RIGHTS ARE RESERVED IN THE EVENT OF THE GRANT OF A PATENT OF THE REGISTRATION OF A UTILITY MODEL OR DESIGN.

PROJECT: PCR_2014.snh
 FILE NAME
 TYPE:

REVISIONS		DATE	31/01/2014	UNIT 1ph+PCR+HEATER 1ph				
LAST REVISION DATE		COMMISS.	OM					
SHEET STATUS	0	CHECK.						
SABIK VERSION	Ver. 16.00	APPROV.		PCR 2014	SHEET	9		
		SUBST.:				10	N.S.	

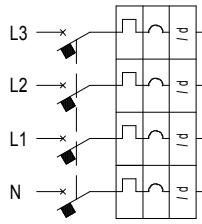

400Vac 3Ph+N 50Hz

LINEA ALIMENTAZIONE:
PREDISPORRE A MONTE
UNA ADEGUATA PROTEZIONE
CON INTERRUTTORE
MAGNETOTERMICO
DIFFERENZIALE

POWER LINE:
PROVIDE A PROPER PROTECTION
WITH DIFFERENTIAL
MAGNETOTHERMAL SWITCH

LIGNE D' ALIMENTATION:
PRÉPAREZ-VOUS A MONTER
UNE PROTECTION ADEQUATE
AVEC INTERRUPTEUR THERMIQUE
DIFFERENTIEL

STROMLEITUNG:
BEREITEN SIE VOR
ANGEMESSENEN SCHUTZ
MIT SCHALTER
magnetothermischen
DIFFERENTIAL

SUMINISTRO DE LÍNEA:
PREPARARSE PARA MONTAR
UN INTERRUPTOR DE CIRCUITO
DE PROTECCIÓN ADECUADA

POWER LINE:
FORNECER:
uma protecção adequada
com diferencial opção
magnetothermal

POWER LINE:
BIEDEN:
EEN GOEDE BESCHERMING
WITH DIFFERENTIEEL
MAGNETOTHERMAL SCHAKELAAR

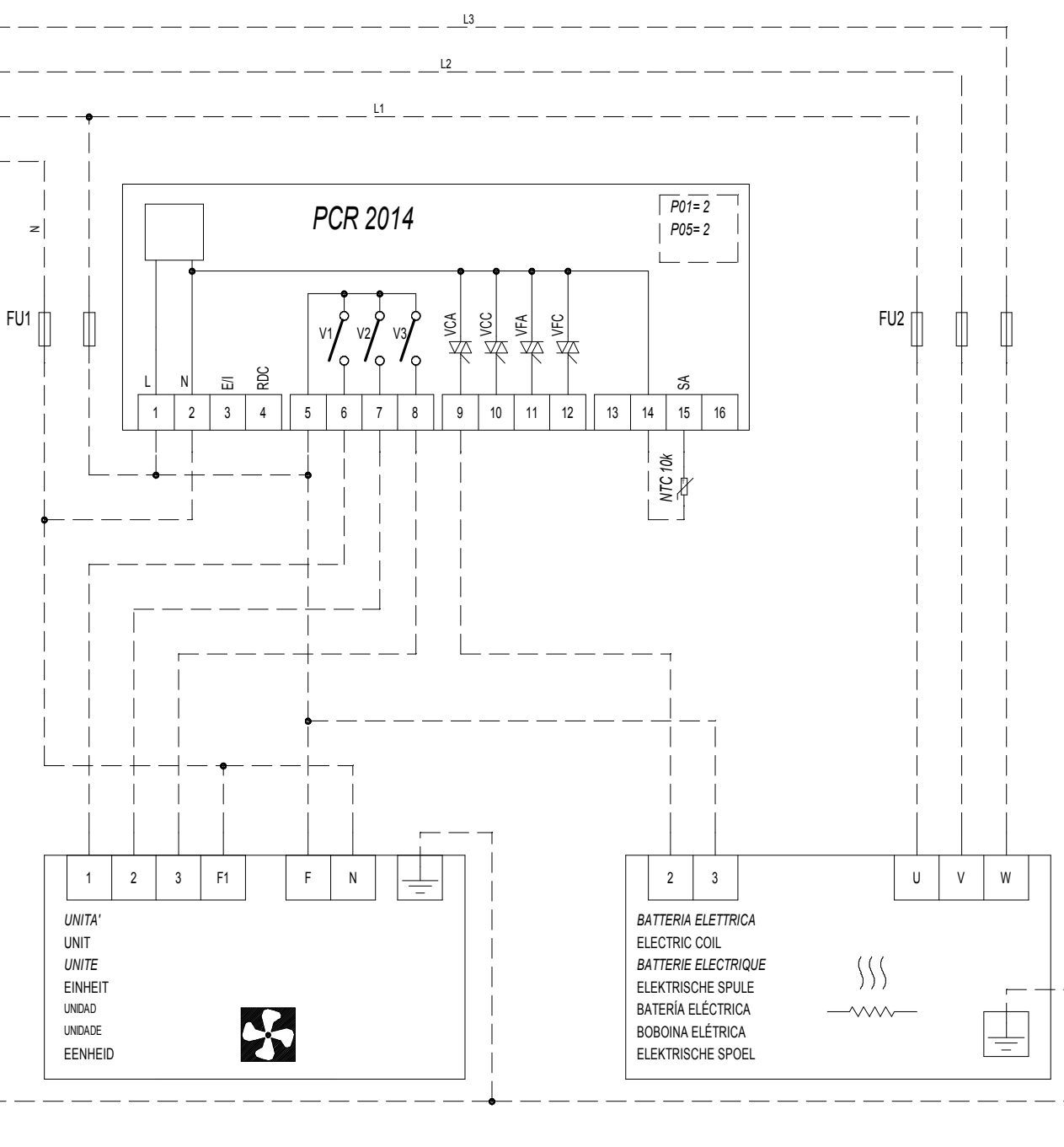
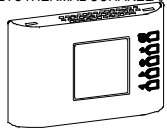

A CURA DELL'INSTALLATORE
A CARE BY THE INSTALLER
AUX SOINS DE L'INSTALLATEUR
Eine Betreuung durch den INSTALLATEUR
A CUIDADO POR EL INSTALADOR
Um cuidado pelo instalador
Een zorg door de INSTALLATEUR

COPYING OF THIS DOCUMENT, AND GIVING IT TO OTHERS AND THE USE OR COMMUNICATION OF THE CONTENTS THEREOF, ARE FORBIDDEN WITHOUT EXPRESS AUTHORITY. OFFENDERS ARE LIABLE TO THE PAYMENT OF DAMAGES. ALL RIGHTS ARE RESERVED IN THE EVENT OF THE GRANT OF A PATENT OF A UTILITY MODEL OR DESIGN.

PROJECT:
FILE NAME
TYPE:

REVISIONS		DATE	31/01/2014
LAST REVISION DATE		COMMISS.	OM
SHEET STATUS	0	CHECK.	
SABIK VERSION	Ver. 16.00	APPROV.	

Subst.:	Sub. For:	Origin:
---------	-----------	---------

Unit 1ph+PCR+HEATER 3ph		=	
		+	
PCR 2014			SHEET 10
			11 N.S.

COPYING OF THIS DOCUMENT, AND GIVING IT TO OTHERS AND THE USE OR COMMUNICATION OF THE CONTENTS THEREOF, ARE FORBIDDEN WITHOUT EXPRESS AUTHORITY. OFFENDERS ARE LIABLE TO THE PAYMENT OF DAMAGES. ALL RIGHTS ARE RESERVED IN THE EVENT OF THE GRANT OF A PATENT OF THE REGISTRATION OF A UTILITY MODEL OR DESIGN.

PROJECT: PCR_2014.sph
FILE NAME
TYPE:

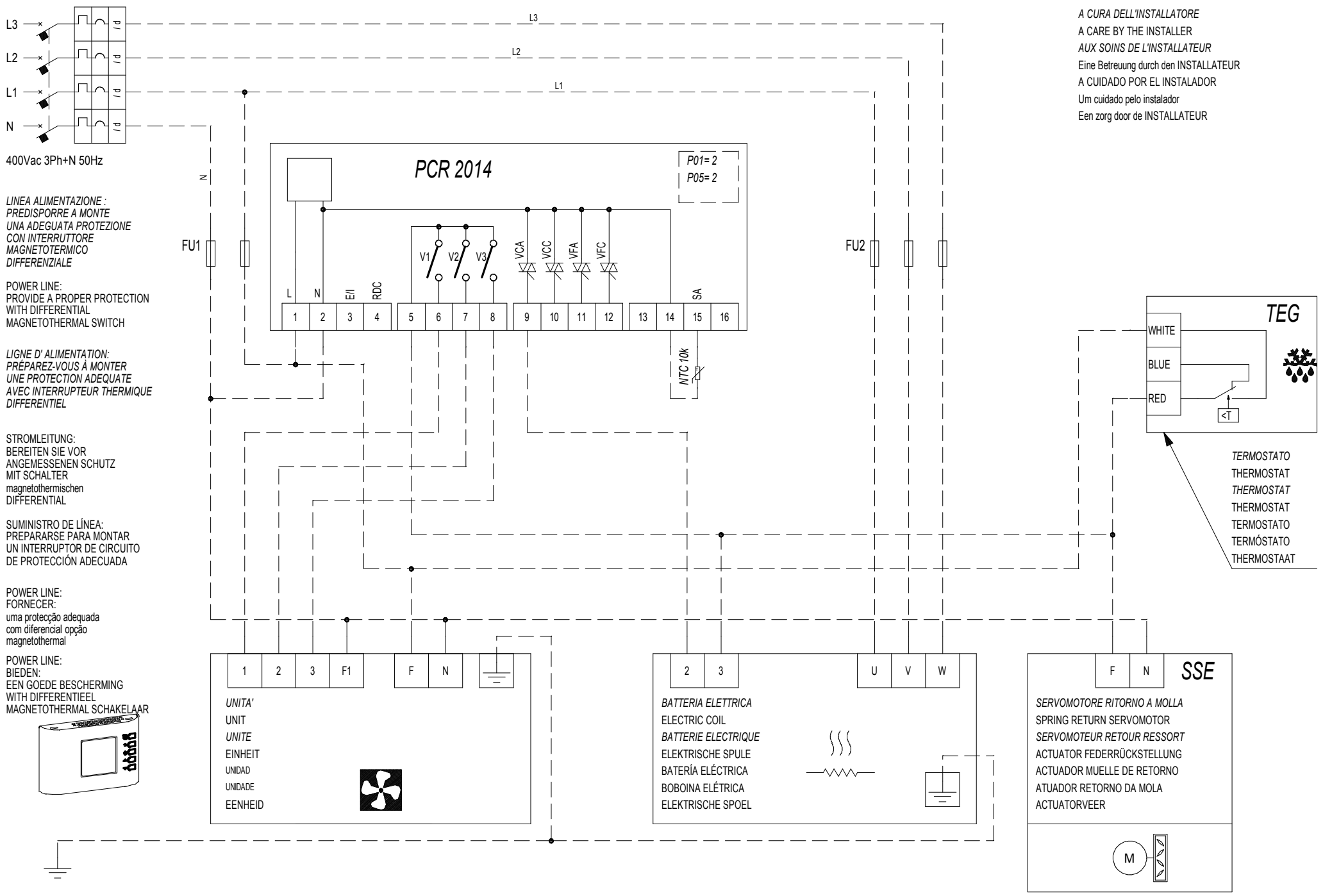

A CURA DELL'INSTALLATORE
 A CARE BY THE INSTALLER
 AUX SOINS DE L'INSTALLATEUR
 Eine Betreuung durch den INSTALLATEUR
 A CUIDADO POR EL INSTALADOR
 Um cuidado pelo instalador
 Een zorg door de INSTALLATEUR

LINEA ALIMENTAZIONE:
 PREDISPORRE A MONTE
 UNA ADEGUATA PROTEZIONE
 CON INTERRUOTORE
 MAGNETOTERMICO
 DIFFERENZIALE

POWER LINE:
 PROVIDE A PROPER PROTECTION
 WITH DIFFERENTIAL
 MAGNETOTHERMAL SWITCH

LIGNE D'ALIMENTATION:
 PRÉPAREZ-VOUS A MONTER
 UNE PROTECTION ADEQUATE
 AVEC INTERRUPTEUR THERMIQUE
 DIFFERENTIEL

STROMLEITUNG:
 BEREITEN SIE VOR
 ANGEMESSENEN SCHUTZ
 MIT SCHALTER
 magnetothermischen
 DIFFERENTIAL

SUMINISTRO DE LÍNEA:
 PREPARARSE PARA MONTAR
 UN INTERRUPTOR DE CIRCUITO
 DE PROTECCIÓN ADECUADA

POWER LINE:
 FORNECER:
 uma protecção adequada
 com diferencial opção
 magnetothermal

POWER LINE:
 BIEDEN:
 EEN GOEDE BESCHERMING
 WITH DIFFERENTIEEL
 MAGNETOTHERMAL SCHAKELAAR

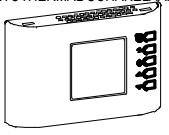

REVISIONS	DATE	18/06/2014	Unit 1ph+PCR+HEATER 3ph+TEG+SSE		=	
LAST REVISION DATE	COMMISS.	O.Meggiolaro			+	
SHEET STATUS	CHECK.				PCR 2014	
SABIK VERSION	APPROV.		SUBST.:	SUB. FOR:	ORIGIN:	SHEET 11 12 N.S.

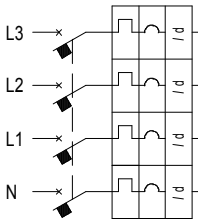

400Vac 3Ph+N 50Hz

LINEA ALIMENTAZIONE :
 PREDISPORRE A MONTE
 UNA ADEGUATA PROTEZIONE
 CON INTERRUTTORE
 MAGNETOTERMICO
 DIFFERENZIALE

POWER LINE:
 PROVIDE A PROPER PROTECTION
 WITH DIFFERENTIAL
 MAGNETOTHERMAL SWITCH

LIGNE D' ALIMENTATION :
 PRÉPAREZ-VOUS A MONTER
 UNE PROTECTION ADEQUATE
 AVEC INTERRUPTEUR THERMIQUE
 DIFFERENTIEL

STROMLEITUNG:
 BEREITEN SIE VOR
 ANGEMESSENEN SCHUTZ
 MIT SCHALTER
 magnetothermischen
 DIFFERENTIAL

SUMINISTRO DE LÍNEA:
 PREPARARSE PARA MONTAR
 UN INTERRUPTOR DE CIRCUITO
 DE PROTECCIÓN ADECUADA

POWER LINE:
 FORNECER:
 uma protecção adequada
 com diferencial opção
 magnetothermal

POWER LINE:
 BIEDEN:
 EEN GOEDE BESCHERMING
 WITH DIFFERENTIEEL
 MAGNETOTHERMAL SCHAKELAAR

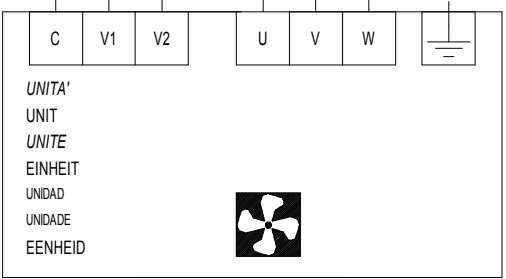
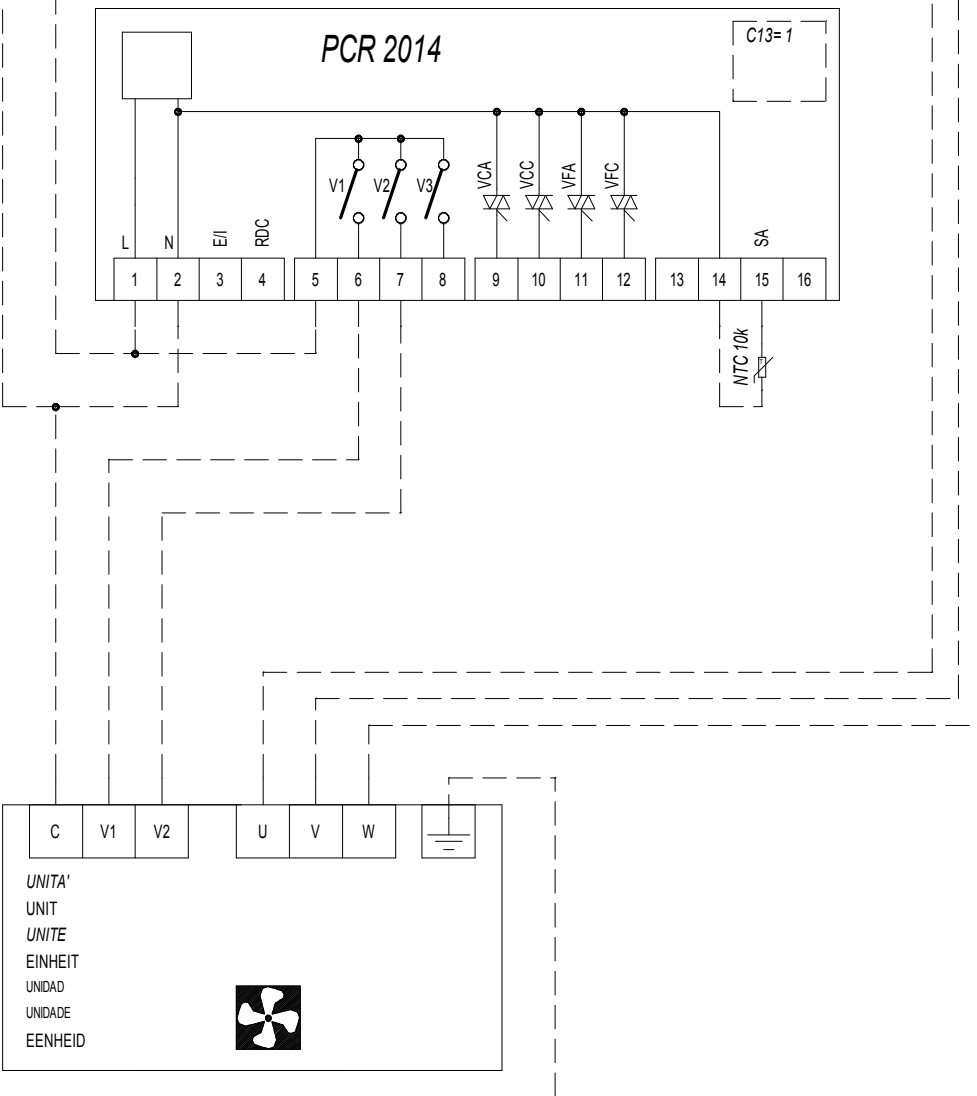
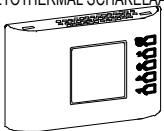

A CURA DELL'INSTALLATORE
 A CARE BY THE INSTALLER
 AUX SOINS DE L'INSTALLATEUR
 Eine Betreuung durch den INSTALLATEUR
 A CUIDADO POR EL INSTALADOR
 Um cuidado pelo instalador
 Een zorg door de INSTALLATEUR

COPYING OF THIS DOCUMENT, AND GIVING IT TO OTHERS AND THE USE OR COMMUNICATION
 OF THE CONTENTS THEREOF, ARE FORBIDDEN WITHOUT EXPRESS AUTHORITY. OFFENDERS
 ARE LIABLE TO THE PAYMENT OF DAMAGES. ALL RIGHTS ARE RESERVED IN THE EVENT
 OF THE GRANT OF A PATENT OF THE REGISTRATION OF A UTILITY MODEL OR DESIGN

PROJECT: PCR_2014.sph
 FILE NAME
 TYPE:

REVISIONS		DATE	18/06/2014	Unit 3ph+PCR		=
LAST REVISION DATE		COMMISS.	O.Meggiolaro			+
SHEET STATUS	1	CHECK.				SHEET 12
SABIK VERSION	Ver. 16.00	APPROV.		SUBST.:	SUB. FOR:	ORIGIN:
					PCR 2014	13 N.S.

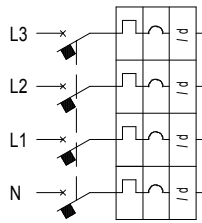

400Vac 3Ph+N 50Hz

LINEA ALIMENTAZIONE:
PREDISPORRE A MONTE
UNA ADEGUATA PROTEZIONE
CON INTERRUTTORE
MAGNETOTERMICO
DIFFERENZIALE

POWER LINE:
PROVIDE A PROPER PROTECTION
WITH DIFFERENTIAL
MAGNETOTHERMAL SWITCH

LIGNE D' ALIMENTATION:
PRÉPAREZ-VOUS A MONTER
UNE PROTECTION ADEQUATE
AVEC INTERRUPTEUR THERMIQUE
DIFFERENTIEL

STROMLEITUNG:
BEREITEN SIE VOR
ANGEMESSENEN SCHUTZ
MIT SCHALTER
magnetothermischen
DIFFERENTIAL

SUMINISTRO DE LÍNEA:
PREPARARSE PARA MONTAR
UN INTERRUPTOR DE CIRCUITO
DE PROTECCIÓN ADECUADA

POWER LINE:
FORNECER:
uma protecção adequada
com diferencial opção
magnetothermal

POWER LINE:
BIEDEN:
EEN GOEDE BESCHERMING
WITH DIFFERENTIEEL
MAGNETOTHERMAL SCHAKELAAR

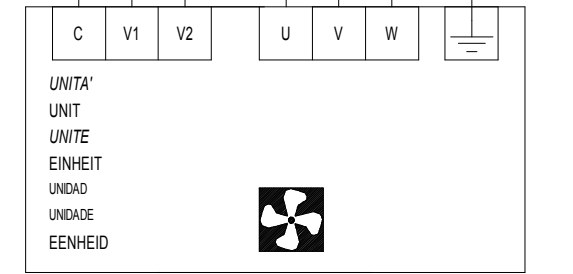
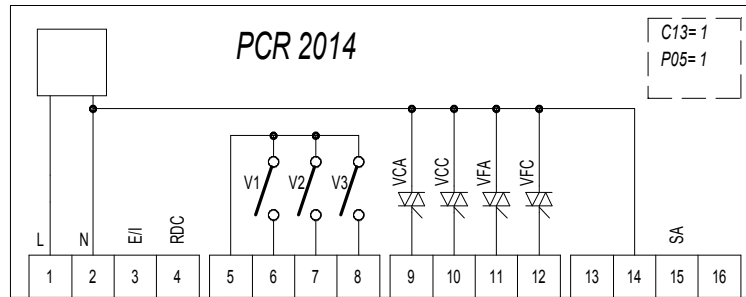
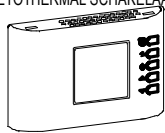

UNITA'
UNIT
UNITE
EINHEIT
UNIDAD
UNIDADE
EENHEID

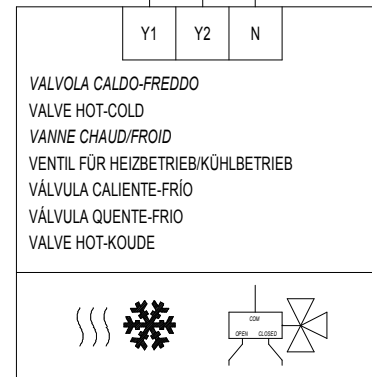

VALVOLA CALDO-FREDDO
VALVE HOT-COLD
VANNE CHAUD/FROID
VENTIL FÜR HEIZBETRIEB/KÜHLBETRIEB
VÁLVULA CALIENTE-FRÍO
VÁLVULA QUENTE-FRIO
VALVE HOT-KOUDE

A CURA DELL'INSTALLATORE
A CARE BY THE INSTALLER
AUX SOINS DE L'INSTALLATEUR
Eine Betreuung durch den INSTALLATEUR
A CUIDADO POR EL INSTALADOR
Um cuidado pelo instalador
Een zorg door de INSTALLATEUR

COPYING OF THIS DOCUMENT, AND GIVING IT TO OTHERS AND THE USE OR COMMUNICATION OF THE CONTENTS THEREOF, ARE FORBIDDEN WITHOUT EXPRESS AUTHORITY. OFFENDERS ARE LIABLE TO THE PAYMENT OF DAMAGES. ALL RIGHTS ARE RESERVED IN THE EVENT OF THE GRANT OF A PATENT OF A UTILITY MODEL OR DESIGN

PROJECT:
FILE NAME
TYPE:

REVISIONS		DATE	18/06/2014
LAST REVISION DATE		COMMISS.	O.Meggiolaro
SHEET STATUS	1	CHECK.	
SABIK VERSION	Ver. 16.00	APPROV.	

Subst.:		Sub. For:		Origin:	
---------	--	-----------	--	---------	--

Unit 3ph+PCR+Hot-ColdCoil			PCR 2014		SHEET 13
					14 N.S.

COPYING OF THIS DOCUMENT, AND GIVING IT TO OTHERS AND THE USE OR COMMUNICATION OF THE CONTENTS THEREOF, ARE FORBIDDEN WITHOUT EXPRESS AUTHORITY. OFFENDERS ARE LIABLE TO THE PAYMENT OF DAMAGES. ALL RIGHTS ARE RESERVED IN THE EVENT OF THE GRANT OF A PATENT OF THE REGISTRATION OF A UTILITY MODEL OR DESIGN.

PROJECT: PCR_2014.sph
 FILE NAME
 TYPE:

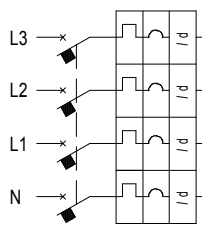

400Vac 3Ph+N 50Hz

LINEA ALIMENTAZIONE :
 PREDISPORRE A MONTE
 UNA ADEGUATA PROTEZIONE
 CON INTERRUPTORE
 MAGNETOTERMICO
 DIFFERENZIALE

POWER LINE:
 PROVIDE A PROPER PROTECTION
 WITH DIFFERENTIAL
 MAGNETOTHERMAL SWITCH

LIGNE D' ALIMENTATION :
 PRÉPAREZ-VOUS A MONTER
 UNE PROTECTION ADEQUATE
 AVEC INTERRUPTEUR THERMIQUE
 DIFFERENTIEL

STROMLEITUNG:
 BEREITEN SIE VOR
 ANGEMESSENEN SCHUTZ
 MIT SCHALTER
 magnetothermischen
 DIFFERENTIAL

SUMINISTRO DE LÍNEA:
 PREPARARSE PARA MONTAR
 UN INTERRUPTOR DE CIRCUITO
 DE PROTECCIÓN ADECUADA

POWER LINE:
 FORNECER:
 uma protecção adequada
 com diferencial opção
 magnetothermal

POWER LINE:
 BIEDEN:
 EEN GOEDE BESCHERMING
 WITH DIFFERENTIEEL
 MAGNETOTHERMAL SCHAKELAAR

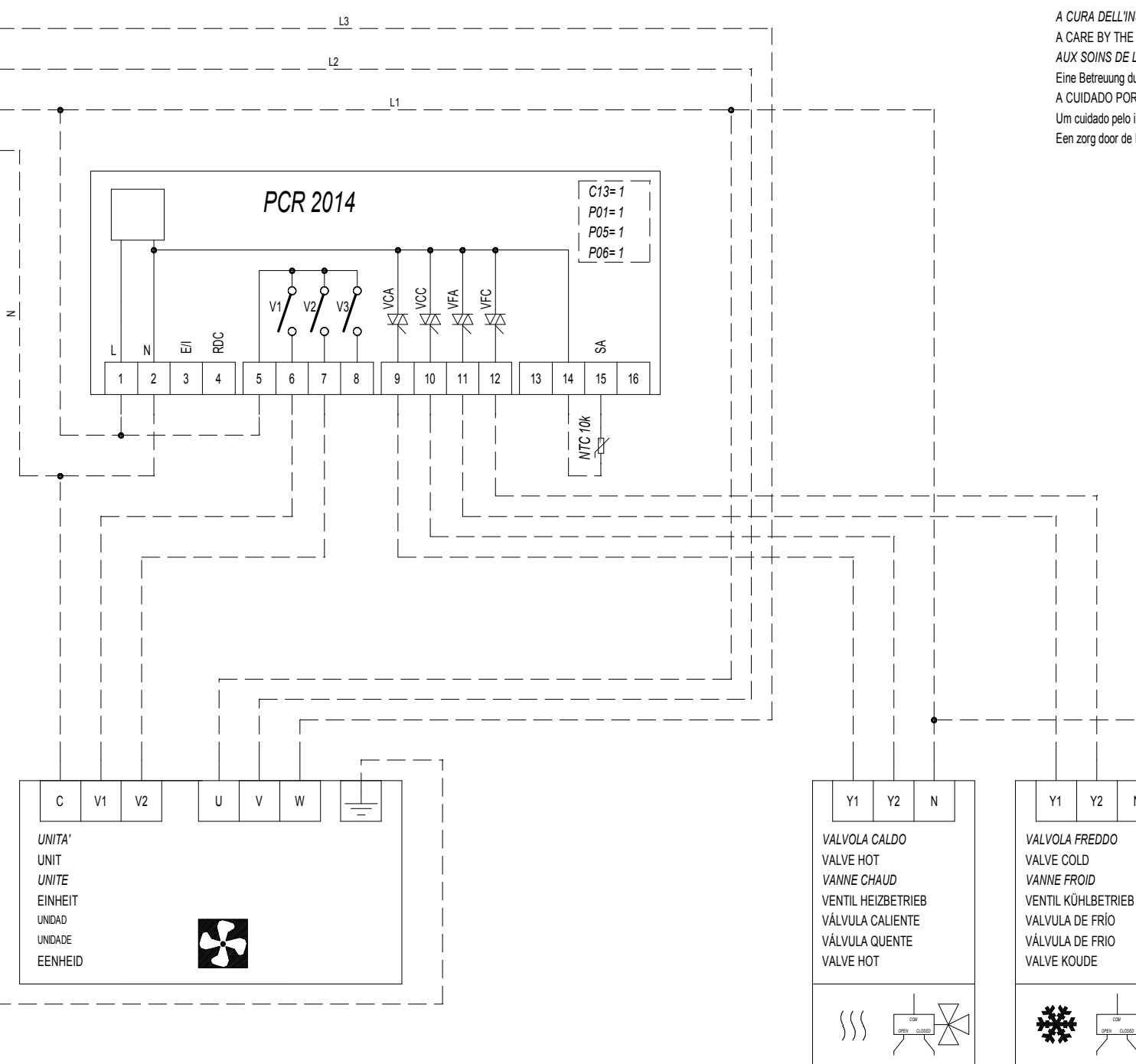
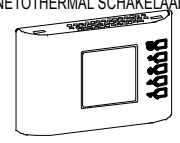

A CURA DELL'INSTALLATORE
 A CARE BY THE INSTALLER
 AUX SOINS DE L'INSTALLATEUR
 Eine Betreuung durch den INSTALLATEUR
 A CUIDADO POR EL INSTALADOR
 Um cuidado pelo instalador
 Een zorg door de INSTALLATEUR

REVISIONS		DATE	03/02/2014
LAST REVISION DATE		COMMISS.	OM
SHEET STATUS	0	CHECK.	
SABIK VERSION	Ver. 16.00	APPROV.	

DATE	03/02/2014	COMMISS.	OM
APPROV.		CHECK.	
ORIGIN:		SUBST.:	
SUB. FOR:		ORIGIN:	

Unit 3ph+PCR+HotCoil+ColdCoil		=	
		+	
		PCR 2014	SHEET 14
		15	N.S.

COPYING OF THIS DOCUMENT, AND GIVING IT TO OTHERS AND THE USE OR COMMUNICATION OF THE CONTENTS THEREOF, ARE FORBIDDEN WITHOUT EXPRESS AUTHORITY. OFFENDERS ARE LIABLE TO THE PAYMENT OF DAMAGES. ALL RIGHTS ARE RESERVED IN THE EVENT OF THE GRANT OF A PATENT OF THE REGISTRATION OF A UTILITY MODEL OR DESIGN.

PROJECT: PCR_2014.sph
 FILE NAME
 TYPE:

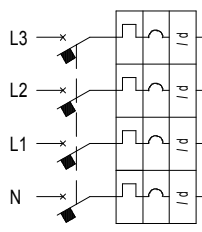

400Vac 3Ph+N 50Hz

LINEA ALIMENTAZIONE:
 PREDISPORRE A MONTE
 UNA ADEGUATA PROTEZIONE
 CON INTERRUPTORE
 MAGNETOTERMICO
 DIFFERENZIALE

POWER LINE:
 PROVIDE A PROPER PROTECTION
 WITH DIFFERENTIAL
 MAGNETOTHERMAL SWITCH

LIGNE D' ALIMENTATION:
 PRÉPAREZ-VOUS A MONTER
 UNE PROTECTION ADEQUATE
 AVEC INTERRUPTEUR THERMIQUE
 DIFFERENTIEL

STROMLEITUNG:
 BEREITEN SIE VOR
 ANGEMESSENEN SCHUTZ
 MIT SCHALTER
 magnetothermischen
 DIFFERENTIAL

SUMINISTRO DE LÍNEA:
 PREPARARSE PARA MONTAR
 UN INTERRUPTOR DE CIRCUITO
 DE PROTECCIÓN ADECUADA

POWER LINE:
 FORNECER:
 uma protecção adequada
 com diferencial opção
 magnetothermal

POWER LINE:
 BIEDEN:
 EEN GOEDE BESCHERMING
 WITH DIFFERENTIEEL
 MAGNETOTHERMAL SCHAKELAAR

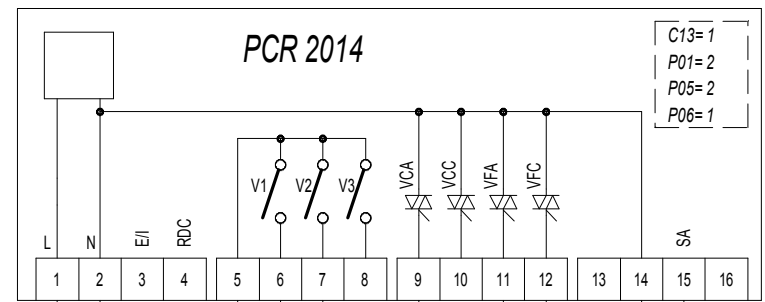
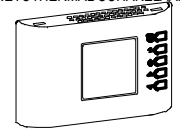

C13=1
 P01=2
 P05=2
 P06=1

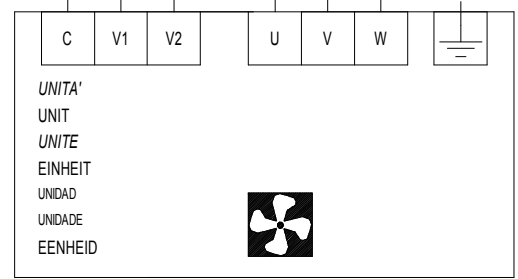
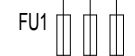

UNITA'
 UNIT
 UNITE
 EINHEIT
 UNIDAD
 UNIDADE
 EENHEID

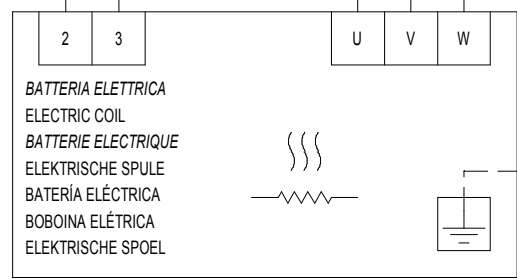

BATTERIA ELETTRICA
 ELECTRIC COIL
 BATTERIE ELECTRIQUE
 ELEKTRISCHE SPULE
 BATERÍA ELÉCTRICA
 BOBOINA ELÉTRICA
 ELEKTRISCHE SPOEL

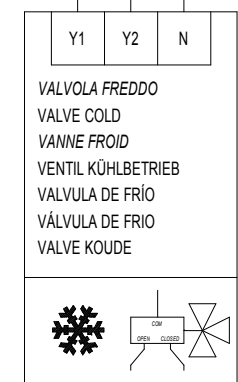

VALVOLA FREDDO
 VALVE COLD
 VANNE FROID
 VENTIL KÜHLBETRIEB
 VALVULA DE FRÍO
 VÁLVULA DE FRIO
 VALVE KOUDE

A CURA DELL'INSTALLATORE
 A CARE BY THE INSTALLER
 AUX SOINS DE L'INSTALLATEUR
 Eine Betreuung durch den INSTALLATEUR
 A CUIDADO POR EL INSTALADOR
 Um cuidado pelo instalador
 Een zorg door de INSTALLATEUR

REVISIONS		DATE	03/02/2014
LAST REVISION DATE		COMMISS.	OM
SHEET STATUS	0	CHECK.	
SABIK VERSION	Ver. 16.00	APPROV.	

Subst.:	Sub. For:	Origin:
---------	-----------	---------

Unit 3ph+PCR+HEATER 3ph+ColdCoil	PCR 2014	SHEET 15
		16 N.S.

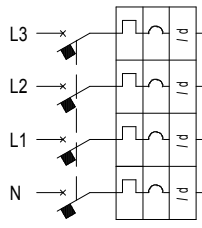

400Vac 3Ph+N 50Hz

LINEA ALIMENTAZIONE:
PREDISPORRE A MONTE
UNA ADEGUATA PROTEZIONE
CON INTERRUPTORE
MAGNETOTERMICO
DIFFERENZIALE

POWER LINE:
PROVIDE A PROPER PROTECTION
WITH DIFFERENTIAL
MAGNETOTHERMAL SWITCH

LIGNE D' ALIMENTATION:
PRÉPAREZ-VOUS A MONTER
UNE PROTECTION ADEQUATE
AVEC INTERRUPTEUR THERMIQUE
DIFFERENTIEL

STROMLEITUNG:
BEREITEN SIE VOR
ANGEMESSENEN SCHUTZ
MIT SCHALTER
magnetothermischen
DIFFERENTIAL

SUMINISTRO DE LÍNEA:
PREPARARSE PARA MONTAR
UN INTERRUPTOR DE CIRCUITO
DE PROTECCIÓN ADECUADA

POWER LINE:
FORNECER:
uma protecção adequada
com diferencial opção
magnetothermal

POWER LINE:
BIEDEN:
EEN GOEDE BESCHERMING
WITH DIFFERENTIEEL
MAGNETOTHERMAL SCHAKELAAR

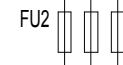
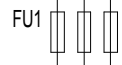
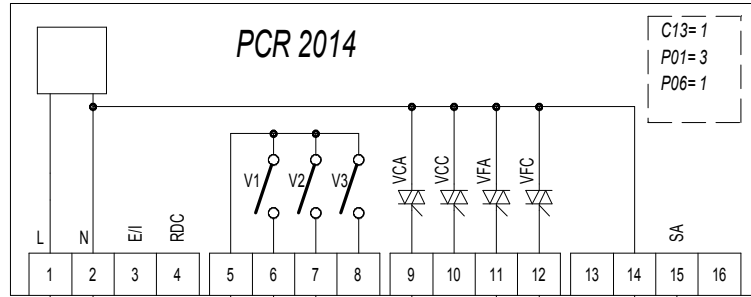
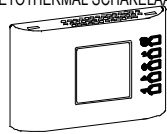

A CURA DELL'INSTALLATORE
A CARE BY THE INSTALLER
AUX SOINS DE L'INSTALLATEUR
Eine Betreuung durch den INSTALLATEUR
Um cuidado pelo instalador
Een zorg door de INSTALLATEUR

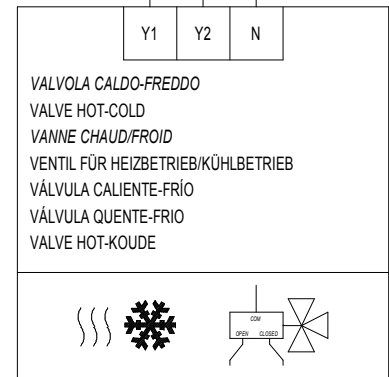
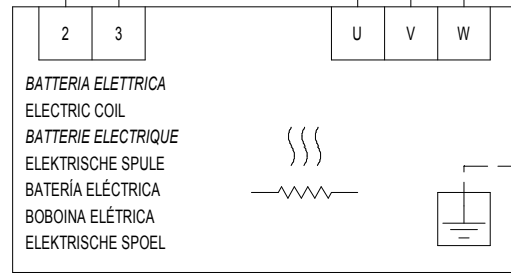
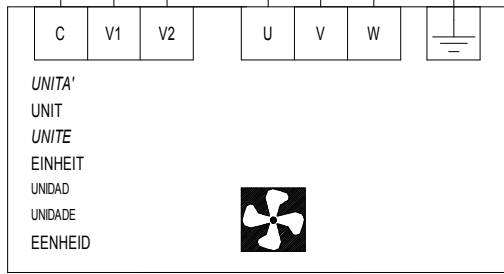

COPYING OF THIS DOCUMENT, AND GIVING IT TO OTHERS AND THE USE OR COMMUNICATION OF THE CONTENTS THEREOF, ARE FORBIDDEN WITHOUT EXPRESS AUTHORITY. OFFENDERS ARE LIABLE TO THE PAYMENT OF DAMAGES. ALL RIGHTS ARE RESERVED IN THE EVENT OF THE GRANT OF A PATENT OF THE REGISTRATION OF A UTILITY MODEL OR DESIGN

PROJECT: PCR_2014.sph
FILE NAME
TYPE:

REVISIONS		DATE	03/02/2014
LAST REVISION DATE		COMMISS.	OM
SHEET STATUS	0	CHECK.	
SABIK VERSION	Ver. 16.00	APPROV.	

SUBST.:	SUB. FOR:	ORIGIN:
---------	-----------	---------

Unit 3ph+PCR+HEATER 3ph+Hot-ColdCoil	PCR 2014	SHEET 16
		17 N.S.

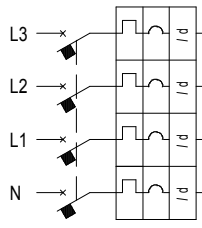

400Vac 3Ph+N 50Hz

LINEA ALIMENTAZIONE:
 PREDISPORRE A MONTE
 UNA ADEGUATA PROTEZIONE
 CON INTERRUPTORE
 MAGNETOTERMICO
 DIFFERENZIALE

POWER LINE:
 PROVIDE A PROPER PROTECTION
 WITH DIFFERENTIAL
 MAGNETOTHERMAL SWITCH

LIGNE D' ALIMENTATION:
 PRÉPAREZ-VOUS A MONTER
 UNE PROTECTION ADEQUATE
 AVEC INTERRUPTEUR THERMIQUE
 DIFFERENTIEL

STROMLEITUNG:
 BEREITEN SIE VOR
 ANGEMESSENEN SCHUTZ
 MIT SCHALTER
 magnetothermischen
 DIFFERENTIAL

SUMINISTRO DE LÍNEA:
 PREPARARSE PARA MONTAR
 UN INTERRUPTOR DE CIRCUITO
 DE PROTECCIÓN ADECUADA

POWER LINE:
 FORNECER:
 uma protecção adequada
 com diferencial opção
 magnetothermal

POWER LINE:
 BIEDEN:
 EEN GOEDE BESCHERMING
 WITH DIFFERENTIEEL
 MAGNETOTHERMAL SCHAKELAAR

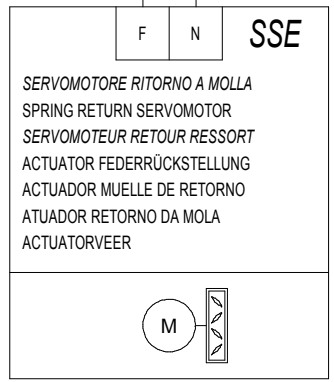
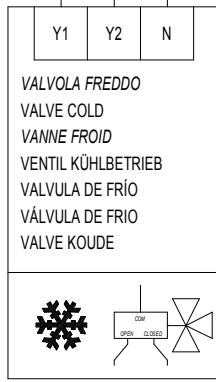
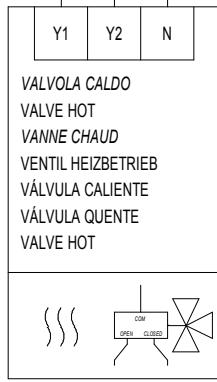
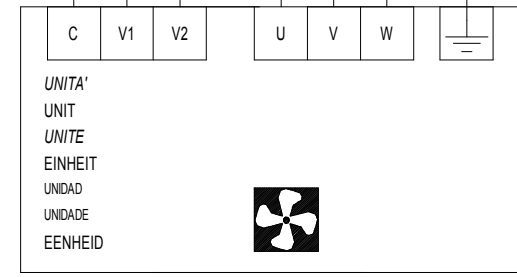
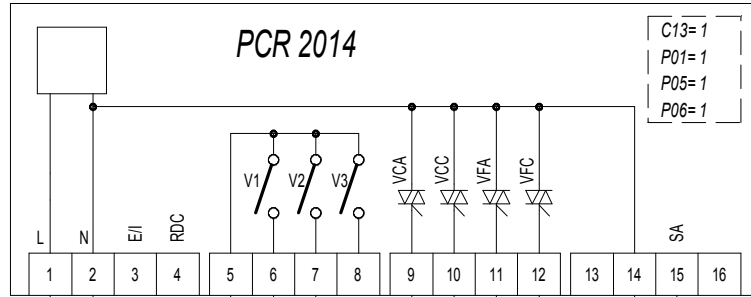
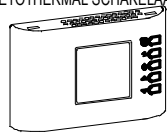

A CURA DELL'INSTALLATORE
 A CARE BY THE INSTALLER
 AUX SOINS DE L'INSTALLATEUR
 Eine Betreuung durch den INSTALLATEUR
 A CUIDADO POR EL INSTALADOR
 Um cuidado pelo instalador
 Een zorg door de INSTALLATEUR

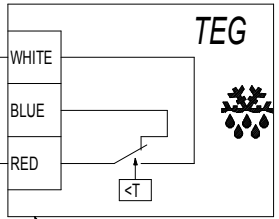

TERMOSTATO
 THERMOSTAT
 THERMOSTAT
 THERMOSTAT
 TERMOSTATO
 THERMOSTAAT

COPYING OF THIS DOCUMENT, AND GIVING IT TO OTHERS AND THE USE OR COMMUNICATION
 OF THE CONTENTS THEREOF, ARE FORBIDDEN WITHOUT EXPRESS AUTHORITY. OFFENDERS
 ARE LIABLE TO THE PAYMENT OF DAMAGES. ALL RIGHTS ARE RESERVED IN THE EVENT
 OF THE GRANT OF A PATENT OF THE REGISTRATION OF A UTILITY MODEL OR DESIGN

PROJECT:
 FILE NAME
 TYPE:

REVISIONS		DATE	18/06/2014
LAST REVISION DATE		COMMISS.	O.Meggiolaro
SHEET STATUS	1	CHECK.	
SABIK VERSION	Ver. 16.00	APPROV.	

Unit 3ph+PCR+HotCoil+ColdCoilTEG+SSE

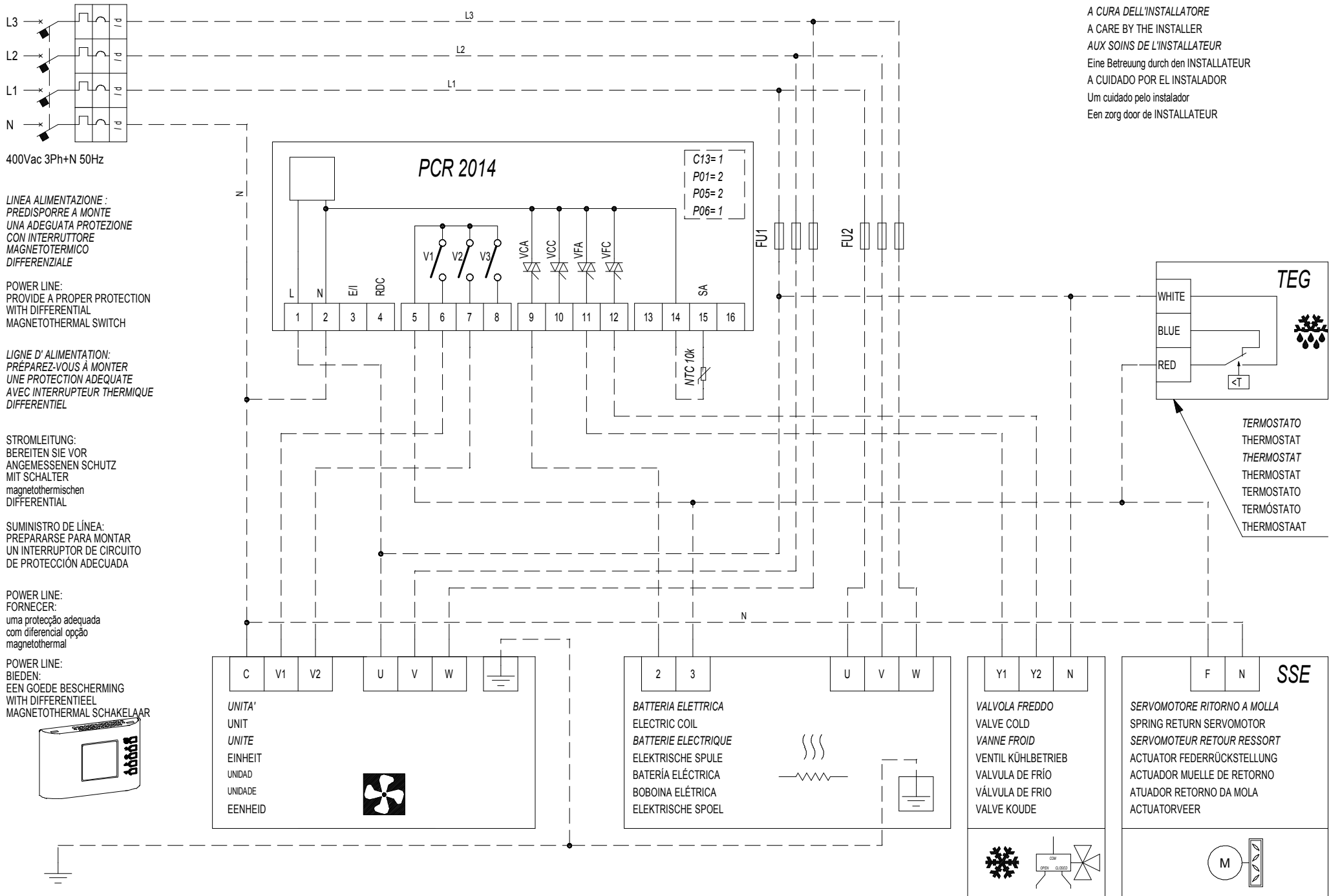

A CURA DELL'INSTALLATORE
A CARE BY THE INSTALLER
AUX SOINS DE L'INSTALLATEUR
Eine Betreuung durch den INSTALLATEUR
A CUIDADO POR EL INSTALADOR
Um cuidado pelo instalador
Een zorg door de INSTALLATEUR

COPYING OF THIS DOCUMENT, AND GIVING IT TO OTHERS AND THE USE OR COMMUNICATION
 OF THE CONTENTS THEREOF, ARE FORBIDDEN WITHOUT EXPRESS AUTHORITY. OFFENDERS
 ARE LIABLE TO THE PAYMENT OF DAMAGES. ALL RIGHTS ARE RESERVED IN THE EVENT
 OF THE GRANT OF A PATENT OF THE REGISTRATION OF A UTILITY MODEL OR DESIGN

REVISIONS		DATE	18/06/2014															
LAST REVISION DATE		COMMISS.	O.Maggiolaro															
SHEET STATUS	1	CHECK.																
SABIK VERSION	Ver. 16.00	APPROV.		SUBST.:		SUB. FOR:		ORIGIN:										
										Unit 3ph+PCR+HEATER 3ph+ColdCoil+Teg+SSE								
															PCR 2014		SHEET	18
																	19	N.S.

COPYING OF THIS DOCUMENT, AND GIVING IT TO OTHERS AND THE USE OR COMMUNICATION
 OF THE CONTENTS THEREOF, ARE FORBIDDEN WITHOUT EXPRESS AUTHORITY. OFFENDERS
 ARE LIABLE TO THE PAYMENT OF DAMAGES. ALL RIGHTS ARE RESERVED IN THE EVENT
 OF THE GRANT OF A PATENT OF THE REGISTRATION OF A UTILITY MODEL OR DESIGN.

PROJECT: PCR_2014.sph
 FILE NAME
 TYPE:

A CURA DELL'INSTALLATORE
 A CARE BY THE INSTALLER
 AUX SOINS DE L'INSTALLATEUR
 Eine Betreuung durch den INSTALLATEUR
 A CUIDADO POR EL INSTALADOR
 Um cuidado pelo instalador
 Een zorg door de INSTALLATEUR

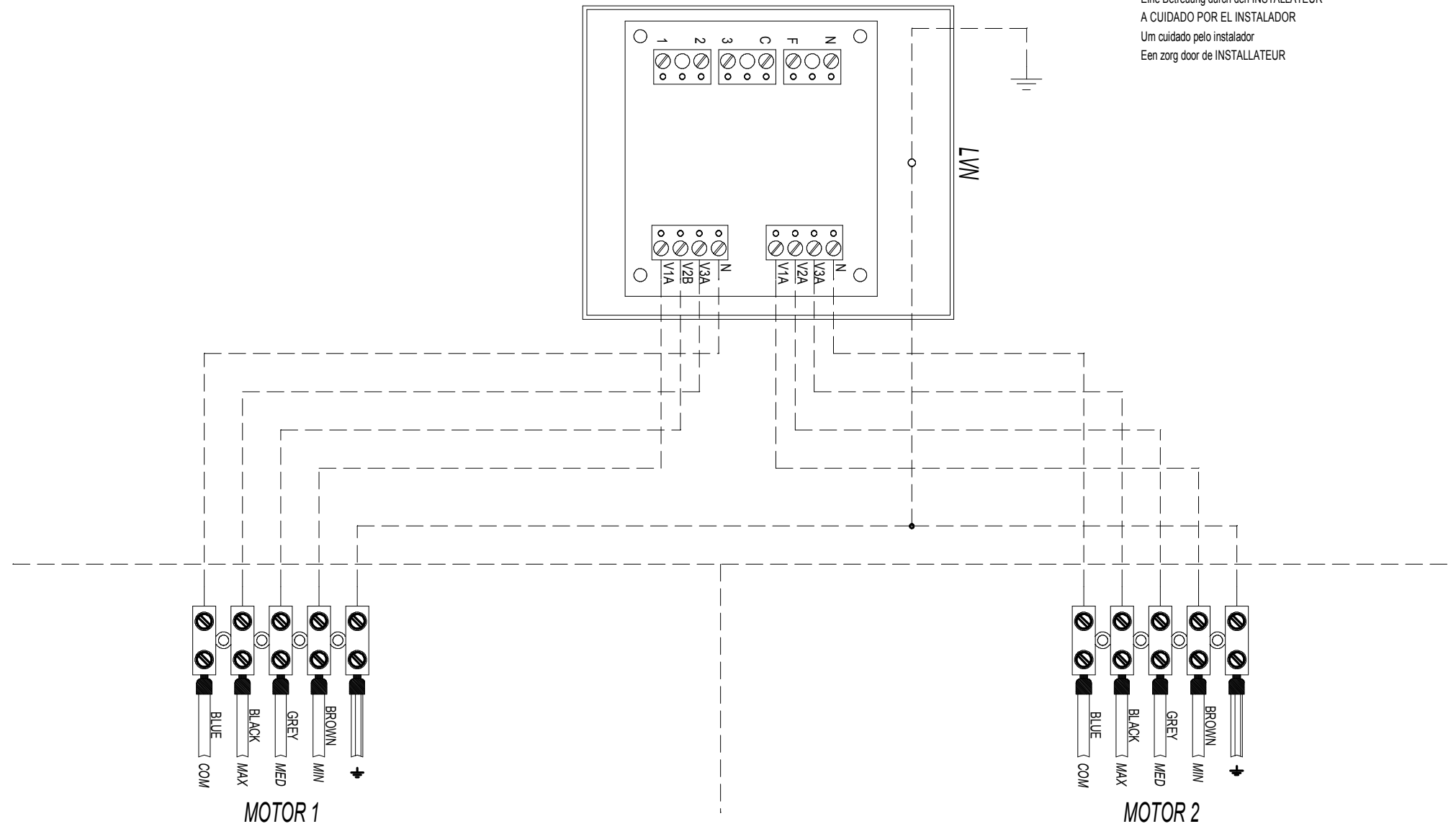

REVISIONS		DATE	26/09/2014	RKB-LVN 1ph		=	
LAST REVISION DATE		COMMISS.	O.Maggiolaro			+	
SHEET STATUS	3	CHECK.				PCR 2014	
SABIK VERSION	Ver. 16.00	APPROV.		SUBST.: 3	SUB. FOR:	ORIGIN:	SHEET 19
1	2	3	4	5	6	7	20 N.S.

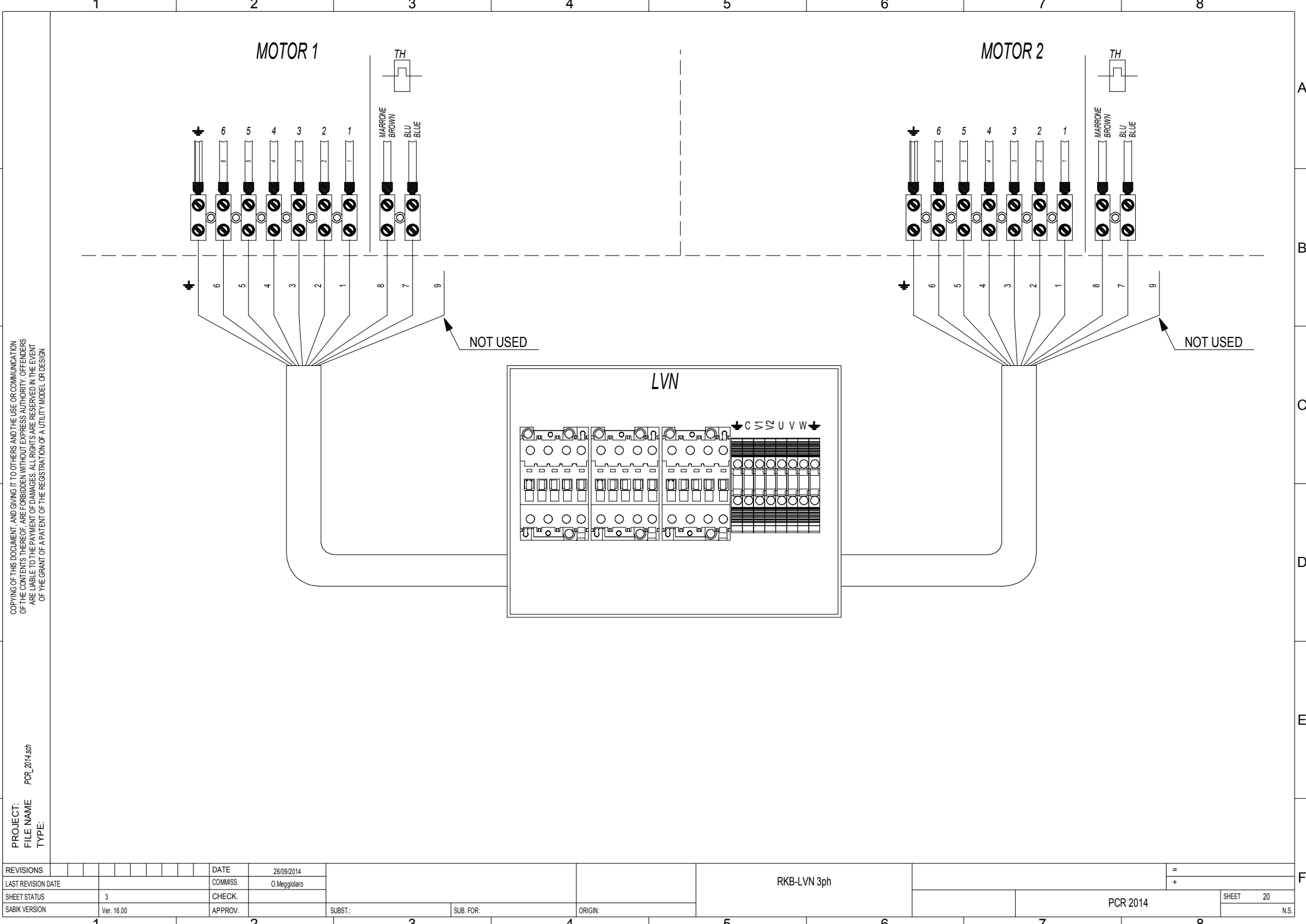

COPYING OF THIS DOCUMENT, AND GIVING IT TO OTHERS AND THE USE OR COMMUNICATION OF THE CONTENTS THEREOF, ARE FORBIDDEN WITHOUT EXPRESS AUTHORITY. OFFENDERS ARE LIABLE TO THE PAYMENT OF DAMAGES. ALL RIGHTS ARE RESERVED IN THE EVENT OF THE GRANT OF A PATENT OF THE REGISTRATION OF A UTILITY MODEL OR DESIGN.

PROJECT: PCR_2014.sph
 FILE NAME:
 TYPE:

REVISIONS		DATE	26/09/2014												
LAST REVISION DATE		COMMISS.	O.Meggiolaro												
SHEET STATUS	3	CHECK.													
SABIK VERSION	Ver. 16.00	APPROV.		SUBST.:	3	SUB. FOR:		ORIGIN:							

RKB-LVN 3ph