

COPYING OF THIS DOCUMENT AND GIVING IT TO OTHERS AND THE USE OR COMMUNICATION OF THE CONTENTS THEREOF ARE FORBIDDEN WITHOUT EXPRESS AUTHORITY. OFFENDERS ARE LIABLE TO THE PAYMENT OF DAMAGES. ALL RIGHTS ARE RESERVED IN THE EVENT OF THE GRANT OF A PATENT OF THE REGISTRATION OF A UTILITY MODEL OR DESIGN.

RKEDDB/FO/BF-RKHDDDB-RKS

CODE

AMF0006850

<i>RKE</i>	<i>RKE</i>	<i>RKE</i>	<i>RKH</i>	<i>RKS</i>
<i>DDB</i>	<i>FO</i>	<i>BF</i>	<i>DDB</i>	
<i>10-60</i>	<i>10-60</i>	<i>10-60</i>	<i>19-60</i>	<i>10-40</i>

DESIGN TYPE				DEFAULT VOLTAGE	230Vac	STANDARD	ENCLOSURE	
SERIE				CONTROLS VOLTAGE	230Vac	+ UBICAZIONE = NOME LOGICO		
ORDER CODE				SIGNALS VOLTAGE	24Vcc			
CUSTOMER						POWER		
DESIGNED WITH CAD/CAE SYSTEM				Sabik		kw		
						CURRENT		
						A		
				DATE	SIGNAT.			
				COMM.	05/06/2015			
				CHECK	05/06/2015			
				APPROV.	05/06/2015			
03	Morsettiara	10/12/2014	O.Meggiolaro					SHEET 0
01	Termico Inverter	21/05/2014	O.Meggiolaro					T.S. 24
REV.	REVISION DESCRIPTION	DATE	COMMISS.	SUB. FOR:		SUBST.:	ORIGIN:	

COPYING OF THIS DOCUMENT, AND GIVING IT TO OTHERS AND THE USE OR COMMUNICATION OF THE CONTENTS THEREOF, ARE FORBIDDEN WITHOUT EXPRESS AUTHORITY. OFFENDERS ARE LIABLE TO THE PAYMENT OF DAMAGES. ALL RIGHTS ARE RESERVED IN THE EVENT OF THE GRANT OF A PATENT OF THE REGISTRATION OF A UTILITY MODEL OR DESIGN.

PROJECT: AMF0006850_03_D01M5.sch
 FILE NAME
 TYPE:

SIMBOLO SYMBOL	DESCRIZIONE DESCRIPTION
○	Morsetto Clamp Borne Klemme Abrazadera braçadeira klem
	Motore trifase 3-phase motor Moteur 3-phase 3-Phasen-Motor 3-fase del motor 3-fase do motor 3-fase motor
	Convertitore tensione AC/DC Voltage converter AC/DC Convertisseur de tension AC/DC Spannungformer AC/DC Conversor de tension AC/DC Conversor de tensao AC/DC Spanningwisselaar AC/DC
	Contatto NA NO contact Contact NO Kontakt schließler NO contacto NO contato maakcontact
	Contatto NC N.C. CONTACT CONTACT N.F. KONTAKT N.G. CONTACTO N.C. CONTACTO N.C. N.C.CONTACT
	UMIDOSTATO HUMIDISTAT HUMIDISTAT HUMIDISTAT HUMIDISTATO UMIDOSTATO HUMIDISTAAT

SIMBOLO SYMBOL	DESCRIZIONE DESCRIPTION
	Contatto NA sensibile alla pressione NO pressure switch Pressostat NO NO Druckschalter sensible a la presión de contacto NO NÃO interruptor de pressão NO drukschakelaar
	Selettore NA con comando rotativo Rotative NO switch Rotative NO interrupteur Rotative Schließler NO interruptor con mando giratorio Interruptor NÃO rotativo Rotative NO-schakelaar
	Selettore NC con comando rotativo Selector switch NC Selecteur NC Wahlschalter NC Selector NC Selector NC Wahlschalter NC
	Contatto NC sensibile alla temperatura NC thermal switch Interrupteur thermique NC NC Thermoschalter NC interruptor térmico NC interruptor térmico NC thermische schakelaar
	Bobina relè Relay coil Bobine relais Relaispule BOBINA REL bobina do relé relaispoel
	Elettrovalvola aperta Solenoid valve open Électrovanne ouverte Magnetventil offen Solenoide de la válvula abierta Válvula solenóide aberto Solenoid klep open

REVISIONS	01	DATE	21/05/2014
LAST REVISION DATE	21/05/2014	COMMISS.	O.Meggiolaro
SHEET STATUS	0	CHECK.	
SABIK VERSION	Ver. 18.00	APPROV.	
		SUBST.:	
		SUB. FOR:	
		ORIGIN:	

RIEPILOGO SIMBOLI SCHEMA

AMF0006850	RKEDDB/FO/BF-RKHDDDB-RKS	SHEET 0-LS-01
		0-LS-02 N.S.

LINEA ALIMENTAZIONE :
 PREDISPORRE A MONTE
 UNA ADEGUATA PROTEZIONE
 CON INTERRUTTORE
 MAGNETOTERMICO
 DIFFERENZIALE

POWER LINE:
 PROVIDE A PROPER PROTECTION
 WITH DIFFERENTIAL
 MAGNETOTHERMAL SWITCH

LIGNE D'ALIMENTATION:
 PRÉPAREZ-VOUS À MONTER
 UNE PROTECTION ADEQUATE
 AVEC INTERRUPTEUR THERMIQUE
 DIFFERENTIEL

STROMLEITUNG:
 BEREITEN SIE VOR
 ANGEMESSENEN SCHUTZ
 MIT SCHALTER
 magnetothermischen
 DIFFERENTIAL

SUMINISTRO DE LÍNEA:
 PREPARARSE PARA MONTAR
 UN INTERRUPTOR DE CIRCUITO
 DE PROTECCIÓN ADECUADA

POWER LINE:
 FORNECER:
 uma protecção adequada
 com diferencial opção
 magnetothermal

POWER LINE:
 BIEDEN:
 EEN GOEDE BESCHERMING
 WITH DIFFERENTIEEL
 MAGNETOTHERMAL SCHAKELAAR

COPYING OF THIS DOCUMENT, AND GIVING IT TO OTHERS AND THE USE OR COMMUNICATION
 OF THE CONTENTS THEREOF, ARE FORBIDDEN WITHOUT EXPRESS AUTHORITY. OFFENDERS
 ARE LIABLE TO THE PAYMENT OF DAMAGES. ALL RIGHTS ARE RESERVED IN THE EVENT
 OF THE GRANT OF A PATENT OF THE REGISTRATION OF A UTILITY MODEL OR DESIGN

PROJECT: AMF0006850_03_D01M5.sch
 FILE NAME
 TYPE:

REVISIONS	01											DATE	05/06/2015
LAST REVISION DATE	21/05/2014		COMMISS.		O.Meggiolaro								
SHEET STATUS	1		CHECK.										
SABIK VERSION	Ver. 18.00		APPROV.				SUBST.:		SUB. FOR:		ORIGIN:		

INVERTER

AMF0006850

RKEDDB/FO/BF-RKHDDB-RKS

SHEET 1
2 N.S.

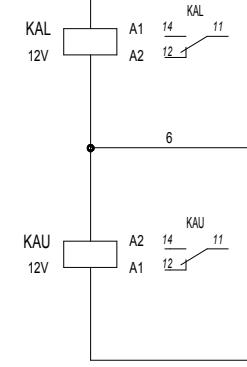
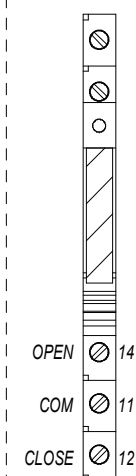
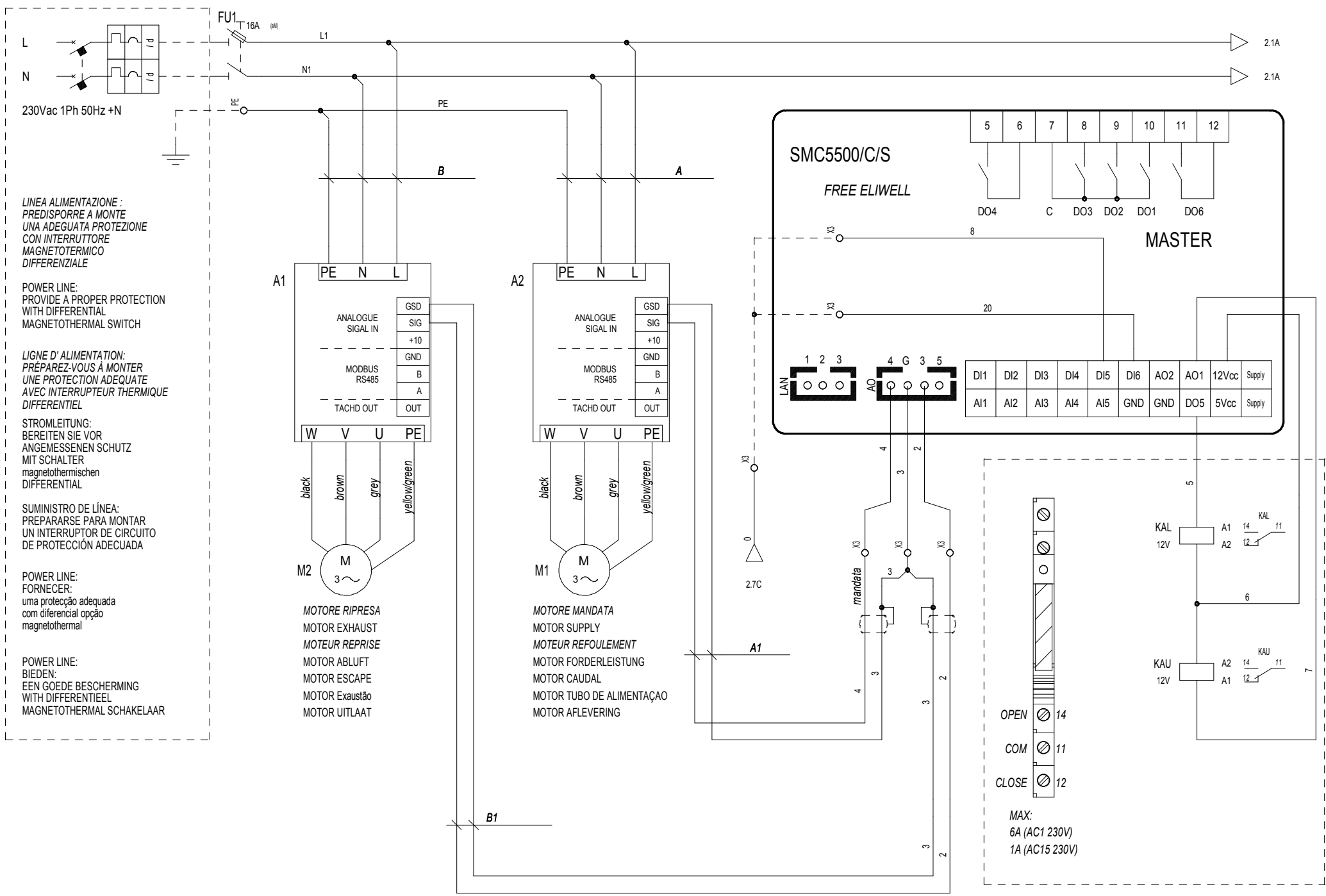

COPYING OF THIS DOCUMENT, AND GIVING IT TO OTHERS AND THE USE OR COMMUNICATION OF THE CONTENTS THEREOF, ARE FORBIDDEN WITHOUT EXPRESS AUTHORITY. OFFENDERS ARE LIABLE TO THE PAYMENT OF DAMAGES. ALL RIGHTS ARE RESERVED IN THE EVENT OF THE GRANT OF A PATENT OF THE REGISTRATION OF A UTILITY MODEL OR DESIGN.

PROJECT: AMF0006850_03_D01M5.sch
 FILE NAME:
 TYPE:

APERTO FREDDO
 OPEN COLD
 OUVERT FROID
 OFFEN KÄLT
 ABIERTO FRÍO
 ABERTO FRÍO
 OPEN KÖLD

REVISIONS	01 03	DATE	10/12/2014	MASTER				
LAST REVISION DATE	10/12/2014	COMMISS.	O.Meggiolaro					
SHEET STATUS	0	CHECK.						
SABIK VERSION	Ver. 18.00	APPROV.		SUBST.:	SUB. FOR:	ORIGIN:	AMF0006850	RKEDDB/FO/BF-RKHDDDB-RKS
							SHEET	2
								3 N.S.

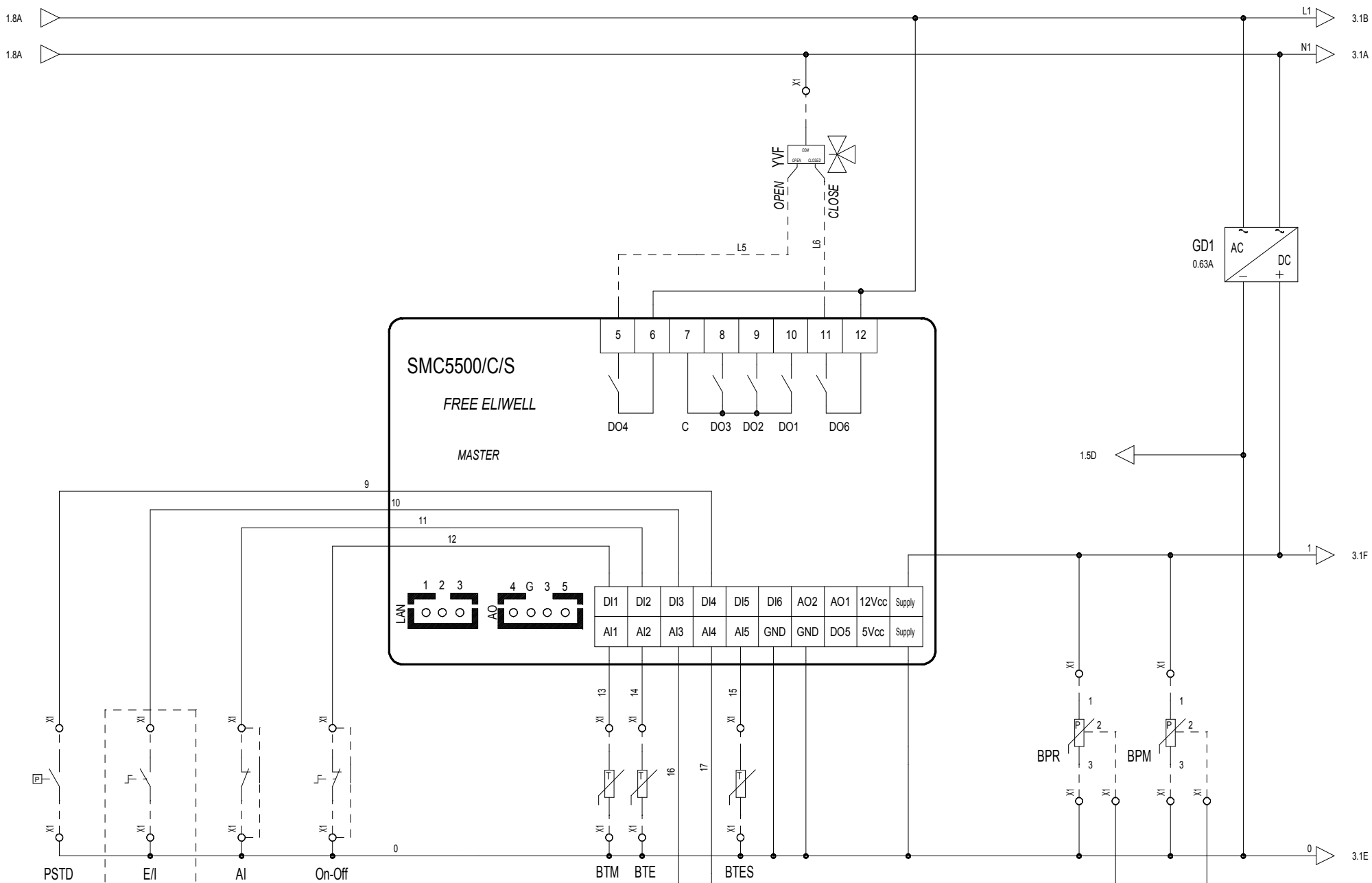

COPYING OF THIS DOCUMENT, AND GIVING IT TO OTHERS AND THE USE OR COMMUNICATION OF THE CONTENTS THEREOF, ARE FORBIDDEN WITHOUT EXPRESS AUTHORITY. OFFENDERS ARE LIABLE TO THE PAYMENT OF DAMAGES. ALL RIGHTS ARE RESERVED IN THE EVENT OF THE GRANT OF A PATENT OF THE REGISTRATION OF A UTILITY MODEL OR DESIGN.

PROJECT: AMF0006850_03_D01M6.sch
 FILE NAME
 TYPE:

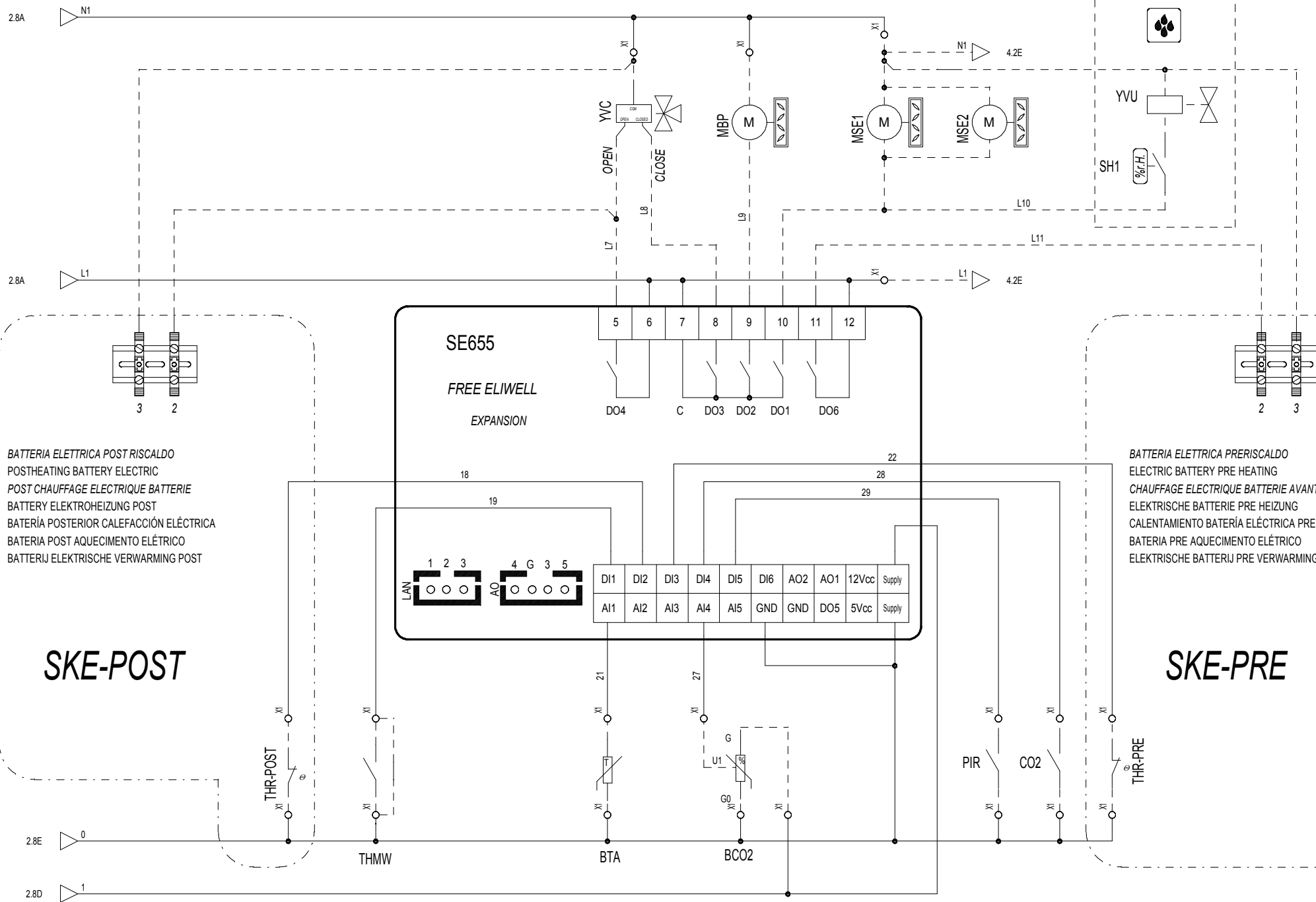

BATTERIA ELETTRICA POST RISCALDO
 POSTHEATING BATTERY ELECTRIC
 POST CHAUFFAGE ELECTRIQUE BATTERIE
 BATTERY ELEKTROHEIZUNG POST
 BATERÍA POSTERIOR CALEFACCIÓN ELÉCTRICA
 BATERIA POST AQUECIMENTO ELÉTRICO
 BATTERIJ ELEKTRISCHE VERWARMING POST

SKE-POST

BATTERIA ELETTRICA PRERISCALDO
 ELECTRIC BATTERY PRE HEATING
 CHAUFFAGE ELECTRIQUE BATTERIE AVANT
 ELEKTRISCHE BATTERIE PRE HEIZUNG
 CALENTAMIENTO BATERÍA ELÉCTRICA PRE
 BATERIA PRE AQUECIMENTO ELÉTRICO
 ELEKTRISCHE BATTERIJ PRE VERWARMING

SKE-PRE

REVISIONS	01 03	DATE	10/12/2014	EXPANSION		AMF0006850	RKEDDB/FO/BF-RKHDDB-RKS	SHEET	3
LAST REVISION DATE	10/12/2014	COMMISS.	O.Maggiolaro					4	N.S.
SHEET STATUS	0	CHECK.							
SABIK VERSION	Ver. 18.00	APPROV.		SUBST.:	SUB. FOR:				

COPYING OF THIS DOCUMENT, AND GIVING IT TO OTHERS AND THE USE OR COMMUNICATION OF THE CONTENTS THEREOF, ARE FORBIDDEN WITHOUT EXPRESS AUTHORITY. OFFENDERS ARE LIABLE TO THE PAYMENT OF DAMAGES. ALL RIGHTS ARE RESERVED IN THE EVENT OF THE GRANT OF A PATENT OF THE REGISTRATION OF A UTILITY MODEL OR DESIGN.

PROJECT: AMF0006850_03_D01M6.sch
 FILE NAME
 TYPE:

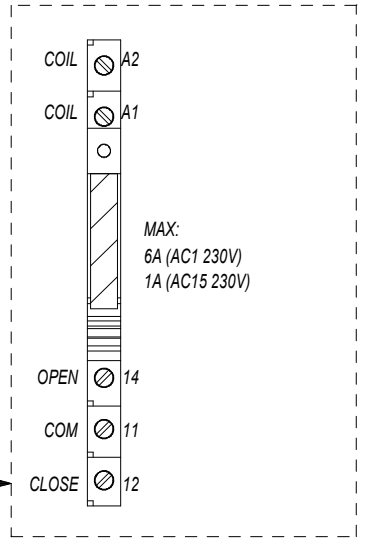
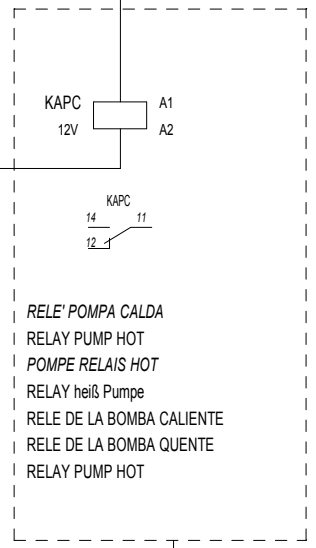
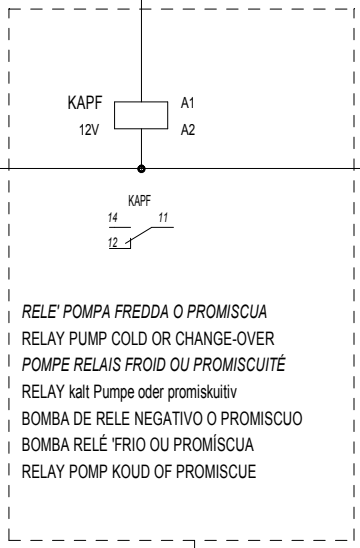
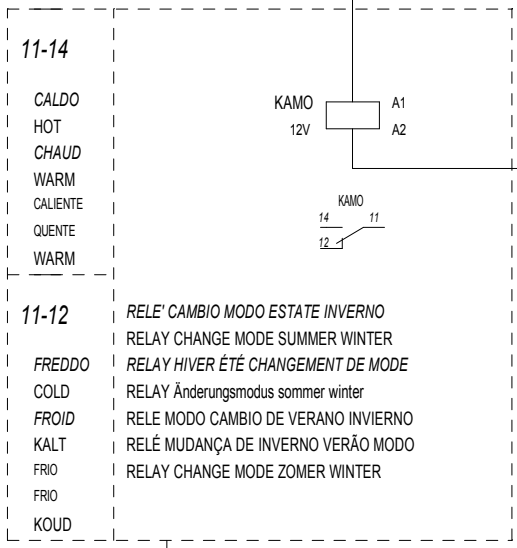
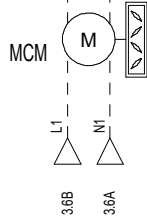
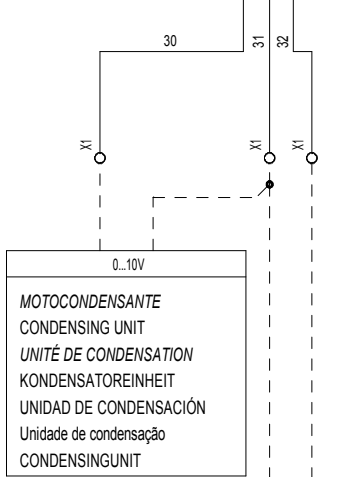
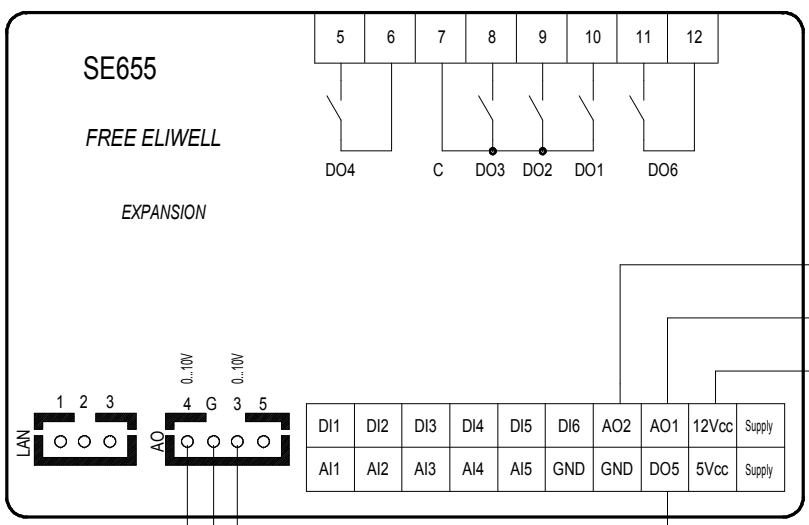

REVISIONS	01 03	DATE	10/12/2014
LAST REVISION DATE	10/12/2014	COMMISS.	O.Maggiolaro
SHEET STATUS	0	CHECK.	
SABIK VERSION	Ver. 18.00	APPROV.	

SUBST.:	SUB. FOR:	ORIGIN:
---------	-----------	---------

EXPANSION RELAY		AMF0006850	RKEDDB/FO/BF-RKHDDB-RKS	SHEET 4
				5 N.S.

PROJECT: AMF0006850_03_D01M6.sch
 FILE NAME: AMF0006850_03_D01M6.sch
 TYPE:

REVISIONS	01									DATE	12/07/2013	
LAST REVISION DATE	21/05/2014							COMMISS.	OM			
SHEET STATUS	0							CHECK.				
SABIK VERSION	Ver. 18.00							APPROV.				

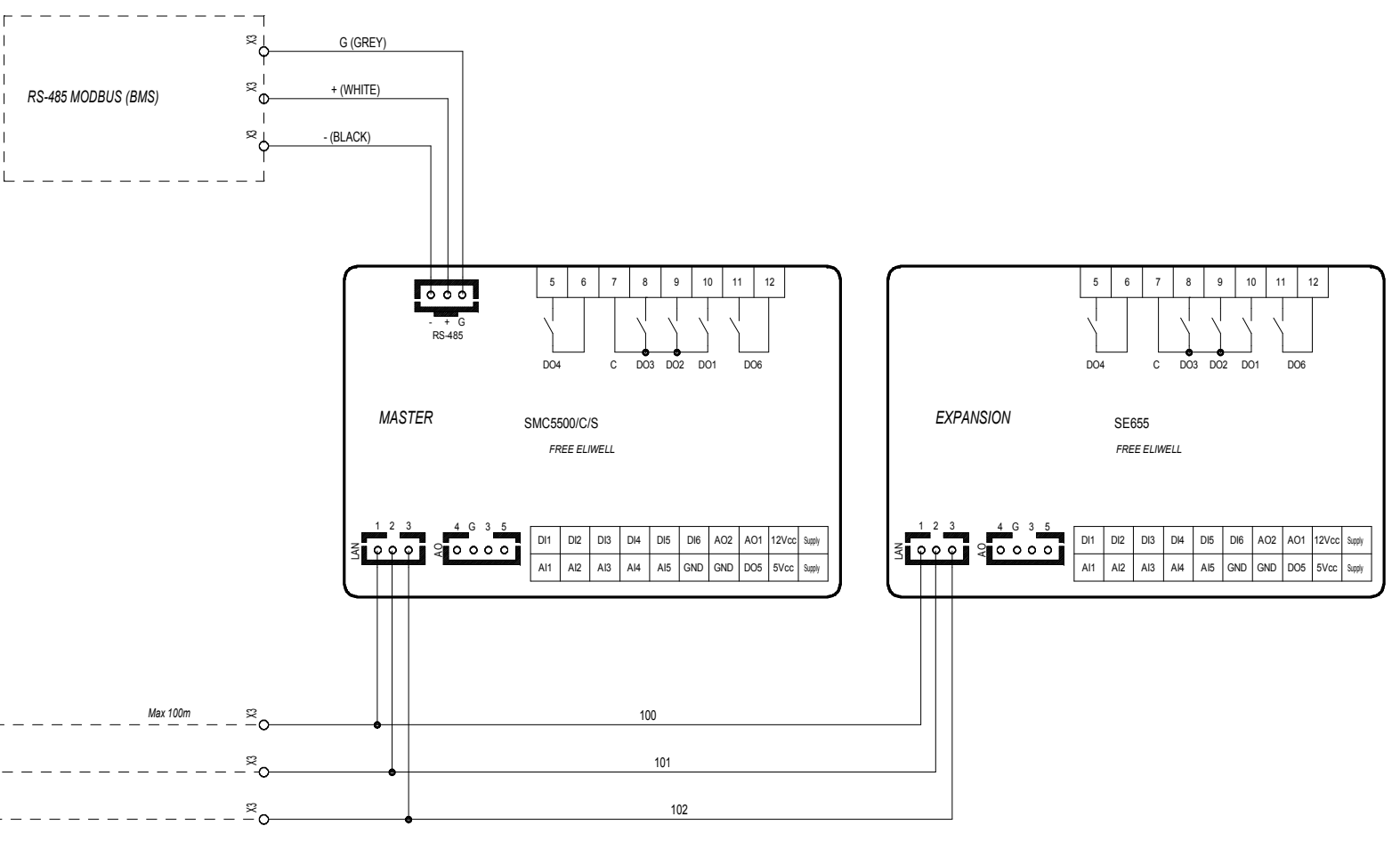

TERMINALE

AMF0006850	RKEDDB/FO/BF-RKHDDB-RKS	SHEET	5
			6

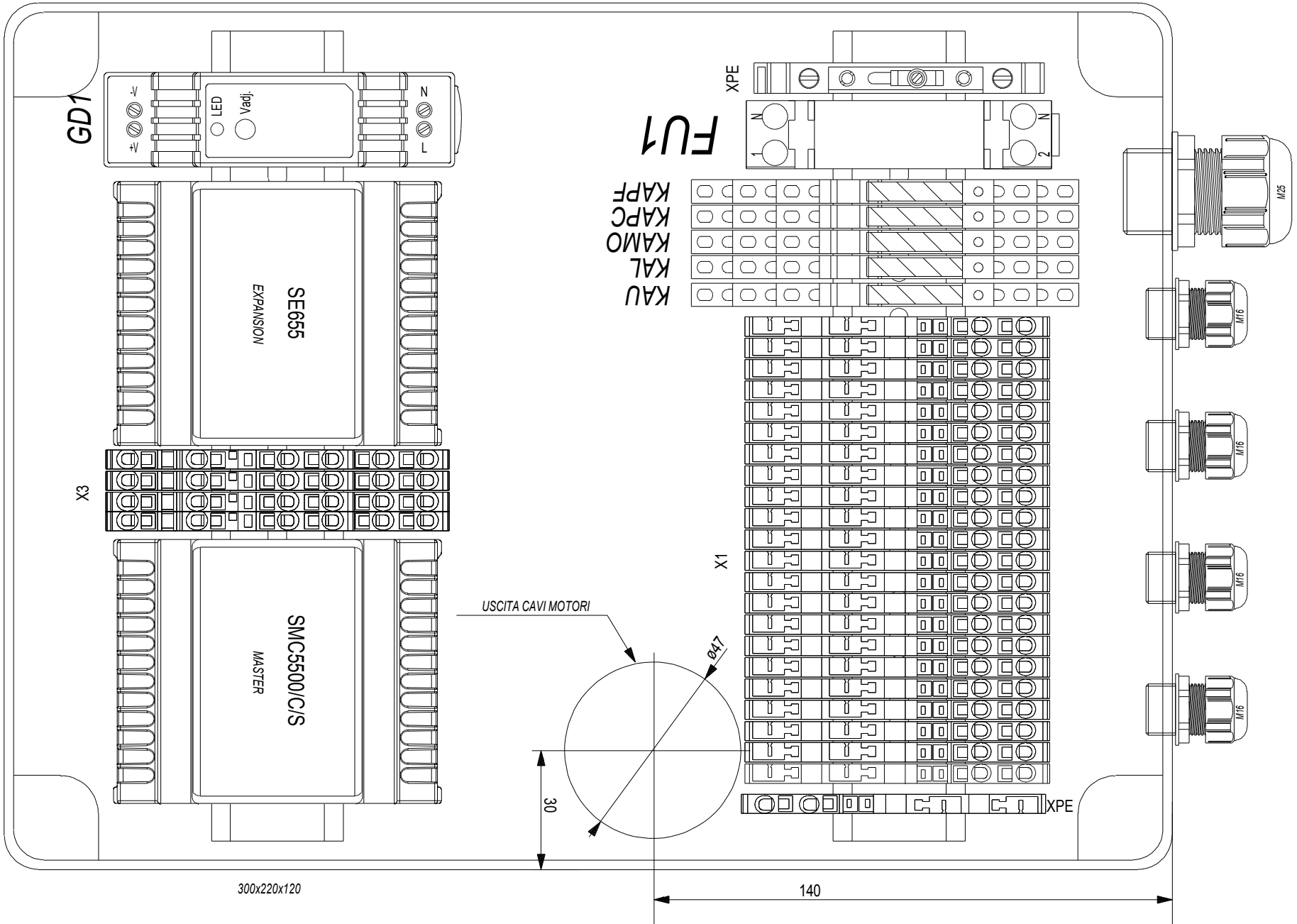

COPYING OF THIS DOCUMENT, AND GIVING IT TO OTHERS AND THE USE OR COMMUNICATION OF THE CONTENTS THEREOF, ARE FORBIDDEN WITHOUT EXPRESS AUTHORITY. OFFENDERS ARE LIABLE TO THE PAYMENT OF DAMAGES. ALL RIGHTS ARE RESERVED IN THE EVENT OF THE GRANT OF A PATENT OF THE REGISTRATION OF A UTILITY MODEL OR DESIGN.

PROJECT: AMF006850_03_D01p.sch
FILE NAME:
TYPE:

REVISIONS	01	03														
LAST REVISION DATE	10/12/2014										DATE		10/12/2014			
SHEET STATUS	0										COMMISS.		O.Maggiolaro			
SABIK VERSION	Ver. 18.00										CHECK.					
	APPROV.										SUBST.:		SUB. FOR:			

ORIGIN:						LAYOUT											
DATE:																	

AMF006850	RKEDDB/FO/BF-RKHDDB-RKS	SHEET	6		
			7	NS.	

COPYING OF THIS DOCUMENT, AND GIVING IT TO OTHERS AND THE USE OR COMMUNICATION OF THE CONTENTS THEREOF, ARE FORBIDDEN WITHOUT EXPRESS AUTHORITY. OFFENDERS ARE LIABLE TO THE PAYMENT OF DAMAGES. ALL RIGHTS ARE RESERVED IN THE EVENT OF THE GRANT OF A PATENT OF THE REGISTRATION OF A UTILITY MODEL OR DESIGN.

PROJECT: AMF0006850_03_D01M5.sch
 FILE NAME
 TYPE:

REVISIONS	01									DATE	21/05/2014
LAST REVISION DATE	21/05/2014								COMMISS.	O.Maggiolaro	
SHEET STATUS	0								CHECK.		
SABIK VERSION	Ver. 18.00								APPROV.		

X1

MORSETTIERA POTENZA

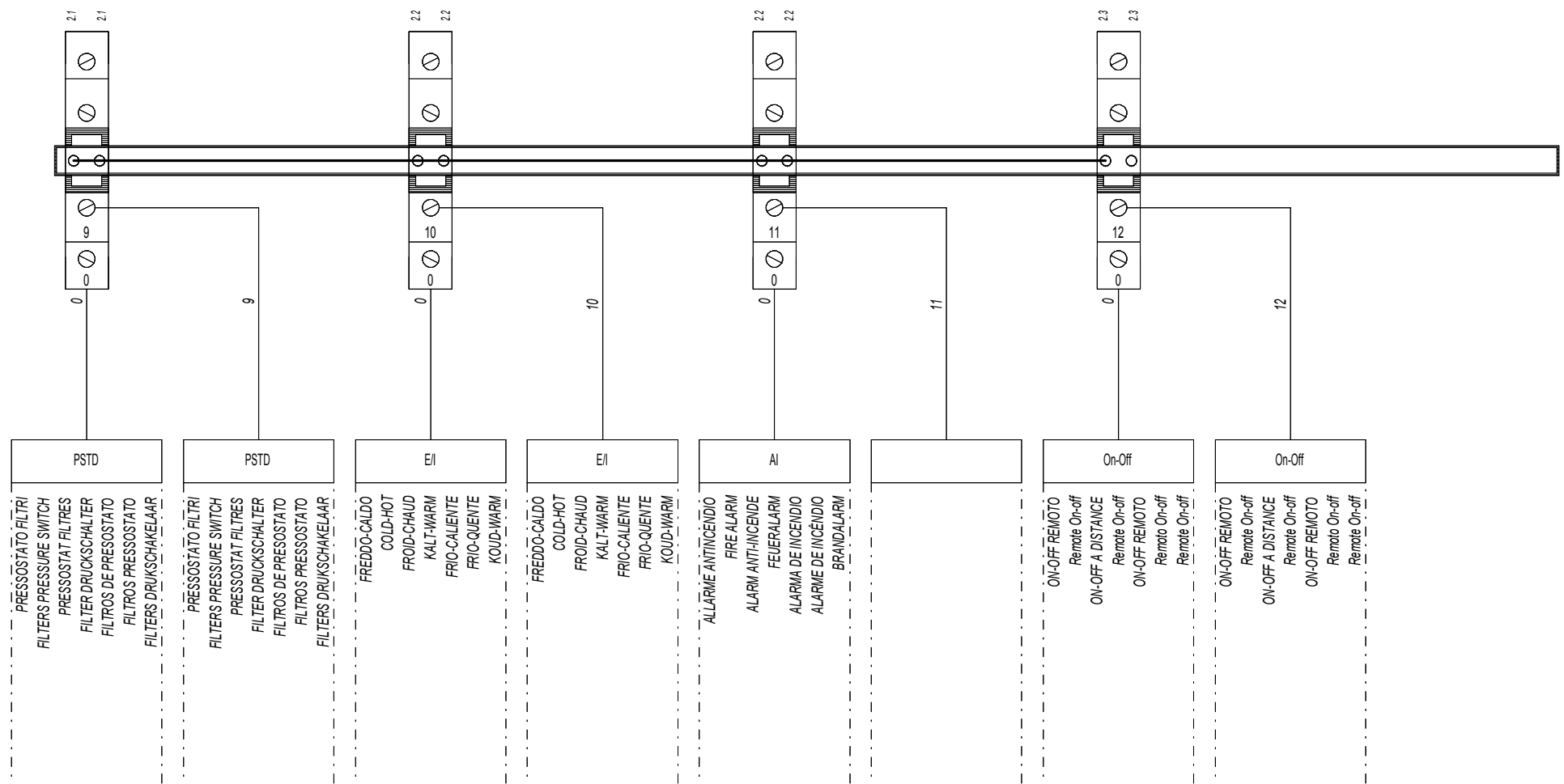

- PSTD**
 - PRESSOSTATO FILTRI
 - FILTERS PRESSURE SWITCH
 - PRESSOSTAT FILTRES
 - FILTER DRUCKSCHALTER
 - FILTROS DE PRESOSTATO
 - FILTROS PRESSOSTATO
 - FILTERS DRUKSCHAKELAAR
- PSTD**
 - PRESSOSTATO FILTRI
 - FILTERS PRESSURE SWITCH
 - PRESSOSTAT FILTRES
 - FILTER DRUCKSCHALTER
 - FILTROS DE PRESOSTATO
 - FILTROS PRESSOSTATO
 - FILTERS DRUKSCHAKELAAR
- E/I**
 - FREDDO-CALDO
 - COLD-HOT
 - FROID-CHAUD
 - KALT-WARM
 - FRIO-CALIENTE
 - FRIO-QUENTE
 - KOUID-WARM
- E/I**
 - FREDDO-CALDO
 - COLD-HOT
 - FROID-CHAUD
 - KALT-WARM
 - FRIO-CALIENTE
 - FRIO-QUENTE
 - KOUID-WARM
- AI**
 - ALLARME ANTINCENDIO
 - FIRE ALARM
 - ALARMI ANTI-INCENDE
 - FEUERALARMI
 - ALARMA DE INCENDIO
 - ALARME DE INCENDIO
 - BRANDALARMI
- On-Off**
 - ON-OFF REMOTO
 - Remote On-off
 - ON-OFF A DISTANCE
 - Remote On-off
 - ON-OFF REMOTO
 - Remote On-off
 - ON-OFF REMOTO
 - Remote On-off
- On-Off**
 - ON-OFF REMOTO
 - Remote On-off
 - ON-OFF A DISTANCE
 - Remote On-off
 - ON-OFF REMOTO
 - Remote On-off
 - ON-OFF REMOTO
 - Remote On-off

RIEPILOGO MORSETTI

AMF0006850	RKEDDB/FO/BF-RKHDDDB-RKS	SHEET	8
			9 N.S.

COPYING OF THIS DOCUMENT, AND GIVING IT TO OTHERS AND THE USE OR COMMUNICATION OF THE CONTENTS THEREOF, ARE FORBIDDEN WITHOUT EXPRESS AUTHORITY. OFFENDERS ARE LIABLE TO THE PAYMENT OF DAMAGES. ALL RIGHTS ARE RESERVED IN THE EVENT OF THE GRANT OF A PATENT OF THE REGISTRATION OF A UTILITY MODEL OR DESIGN.

PROJECT: AMF0006850_03_D01M6.sch
FILE NAME
TYPE:

REVISIONS	01	03								DATE	10/12/2014
LAST REVISION DATE	10/12/2014								COMMISS.	O.Maggiolino	
SHEET STATUS	0								CHECK.		
SABIK VERSION	Ver. 18.00								APPROV.		

X1

MORSETTIERA POTENZA

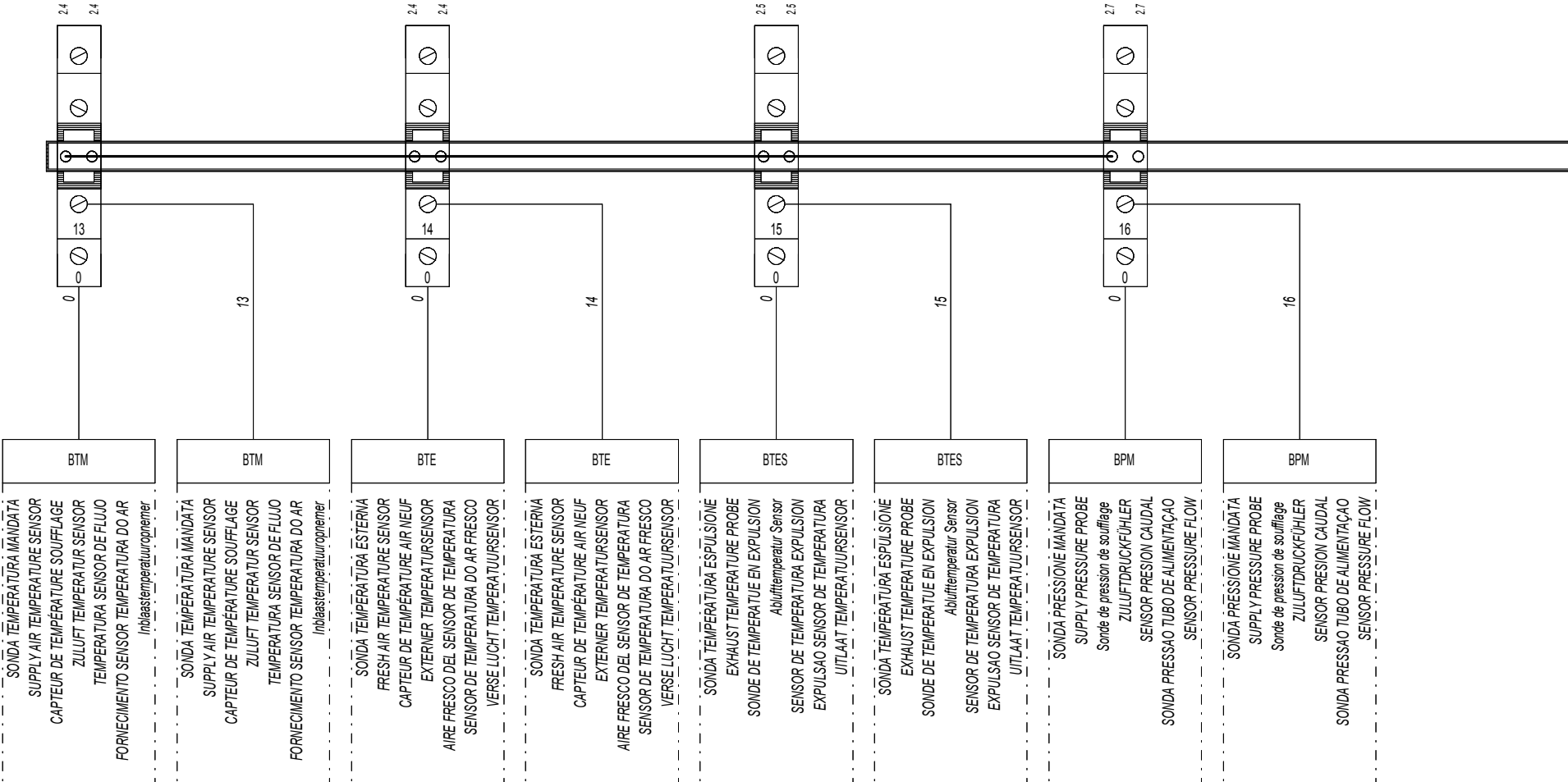

- BTM**
 SONDA TEMPERATURA MANDATA
 SUPPLY AIR TEMPERATURE SENSOR
 CAPTEUR DE TEMPERATURE SOUFFLAGE
 ZULUFT TEMPERATUR SENSOR
 TEMPERATURA SENSOR DE FLUJO
 FORNECIMENTO SENSOR TEMPERATURA DO AR
 Inblaastemperaturopriemer
- BTM**
 SONDA TEMPERATURA MANDATA
 SUPPLY AIR TEMPERATURE SENSOR
 CAPTEUR DE TEMPERATURE SOUFFLAGE
 ZULUFT TEMPERATUR SENSOR
 TEMPERATURA SENSOR DE FLUJO
 FORNECIMENTO SENSOR TEMPERATURA DO AR
 Inblaastemperaturopriemer
- BTE**
 SONDA TEMPERATURA ESTERNA
 FRESH AIR TEMPERATURE SENSOR
 CAPTEUR DE TEMPERATURE AIR NEUF
 EXTERNER TEMPERATURSENSOR
 AIRE FRESCO DEL SENSOR DE TEMPERATURA
 SENSOR DE TEMPERATURA DO AR FRESCO
 VERSE LUCHT TEMPERATUURSENSOR
- BTE**
 SONDA TEMPERATURA ESTERNA
 FRESH AIR TEMPERATURE SENSOR
 CAPTEUR DE TEMPERATURE AIR NEUF
 EXTERNER TEMPERATURSENSOR
 AIRE FRESCO DEL SENSOR DE TEMPERATURA
 SENSOR DE TEMPERATURA DO AR FRESCO
 VERSE LUCHT TEMPERATUURSENSOR
- BTES**
 SONDA TEMPERATURA ESPULSIONE
 EXHAUST TEMPERATURE PROBE
 SONDE DE TEMPERATURE EN EXPULSION
 Ablufttemperatur Sensor
 SENSOR DE TEMPERATURA EXPULSION
 EXPULSAO SENSOR DE TEMPERATURA
 UITLAAT TEMPERATUURSENSOR
- BTES**
 SONDA TEMPERATURA ESPULSIONE
 EXHAUST TEMPERATURE PROBE
 SONDE DE TEMPERATURE EN EXPULSION
 Ablufttemperatur Sensor
 SENSOR DE TEMPERATURA EXPULSION
 EXPULSAO SENSOR DE TEMPERATURA
 UITLAAT TEMPERATUURSENSOR
- BPM**
 SONDA PRESSIONE MANDATA
 SUPPLY PRESSURE PROBE
 Sonde de pression de soufflage
 ZULUFTDRUCKFUHLER
 SENSOR PRESSION CAUDAL
 SONDAS PRESSAO TUBO DE ALIMENTAÇÃO
 SENSOR PRESSURE FLOW
- BPM**
 SONDA PRESSIONE MANDATA
 SUPPLY PRESSURE PROBE
 Sonde de pression de soufflage
 ZULUFTDRUCKFUHLER
 SENSOR PRESSION CAUDAL
 SONDAS PRESSAO TUBO DE ALIMENTAÇÃO
 SENSOR PRESSURE FLOW

RIEPILOGO MORSETTI

COPYING OF THIS DOCUMENT, AND GIVING IT TO OTHERS AND THE USE OR COMMUNICATION OF THE CONTENTS THEREOF, ARE FORBIDDEN WITHOUT EXPRESS AUTHORITY. OFFENDERS ARE LIABLE TO THE PAYMENT OF DAMAGES. ALL RIGHTS ARE RESERVED IN THE EVENT OF THE GRANT OF A PATENT OF THE REGISTRATION OF A UTILITY MODEL OR DESIGN.

PROJECT: AMF0006850_03_D01M6.sph
 FILE NAME
 TYPE:

X1

MORSETTIERA POTENZA

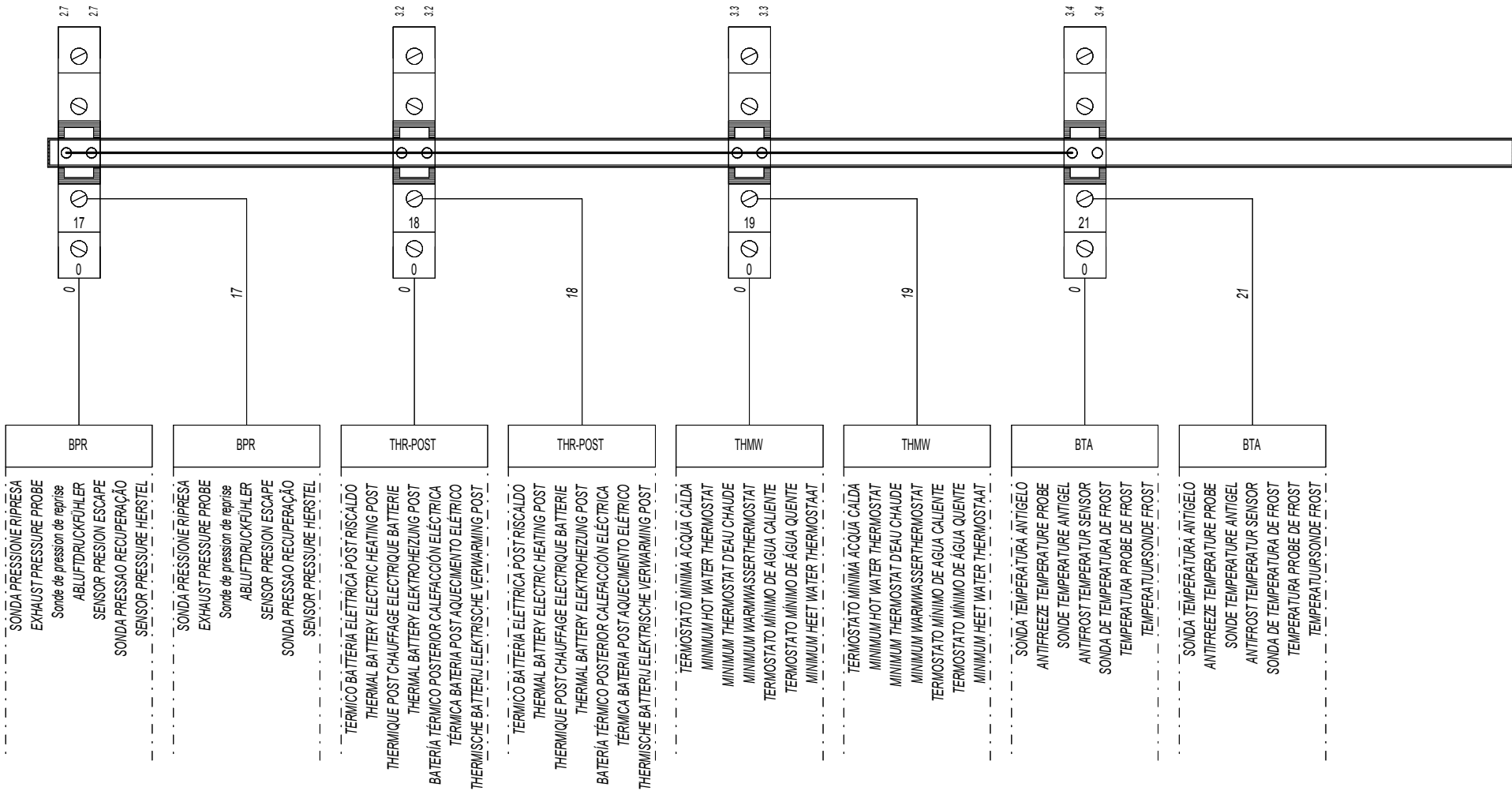

REVISIONS	01	03									DATE	10/12/2014
LAST REVISION DATE	10/12/2014									COMMISS.	O.Maggiolaro	
SHEET STATUS	0									CHECK.		
SABIK VERSION	Ver. 18.00									APPROV.		
	SUBST.:									SUB. FOR:		
										ORIGIN:		

RIEPILOGO MORSETTI

AMF0006850

RKEDDB/FO/BF-RKHDDB-RKS

SHEET 10
11 NS

COPYING OF THIS DOCUMENT, AND GIVING IT TO OTHERS AND THE USE OR COMMUNICATION OF THE CONTENTS THEREOF, ARE FORBIDDEN WITHOUT EXPRESS AUTHORITY. OFFENDERS ARE LIABLE TO THE PAYMENT OF DAMAGES. ALL RIGHTS ARE RESERVED IN THE EVENT OF THE GRANT OF A PATENT OF THE REGISTRATION OF A UTILITY MODEL OR DESIGN.

PROJECT: AMF0006850_03_D01M6.sch
FILE NAME
TYPE:

REVISIONS	01	03								DATE	10/12/2014
LAST REVISION DATE	10/12/2014								COMMISS.	O.Maggiolaro	
SHEET STATUS	0								CHECK.		
SABIK VERSION	Ver. 18.00								APPROV.		

X1

MORSETTIERA POTENZA

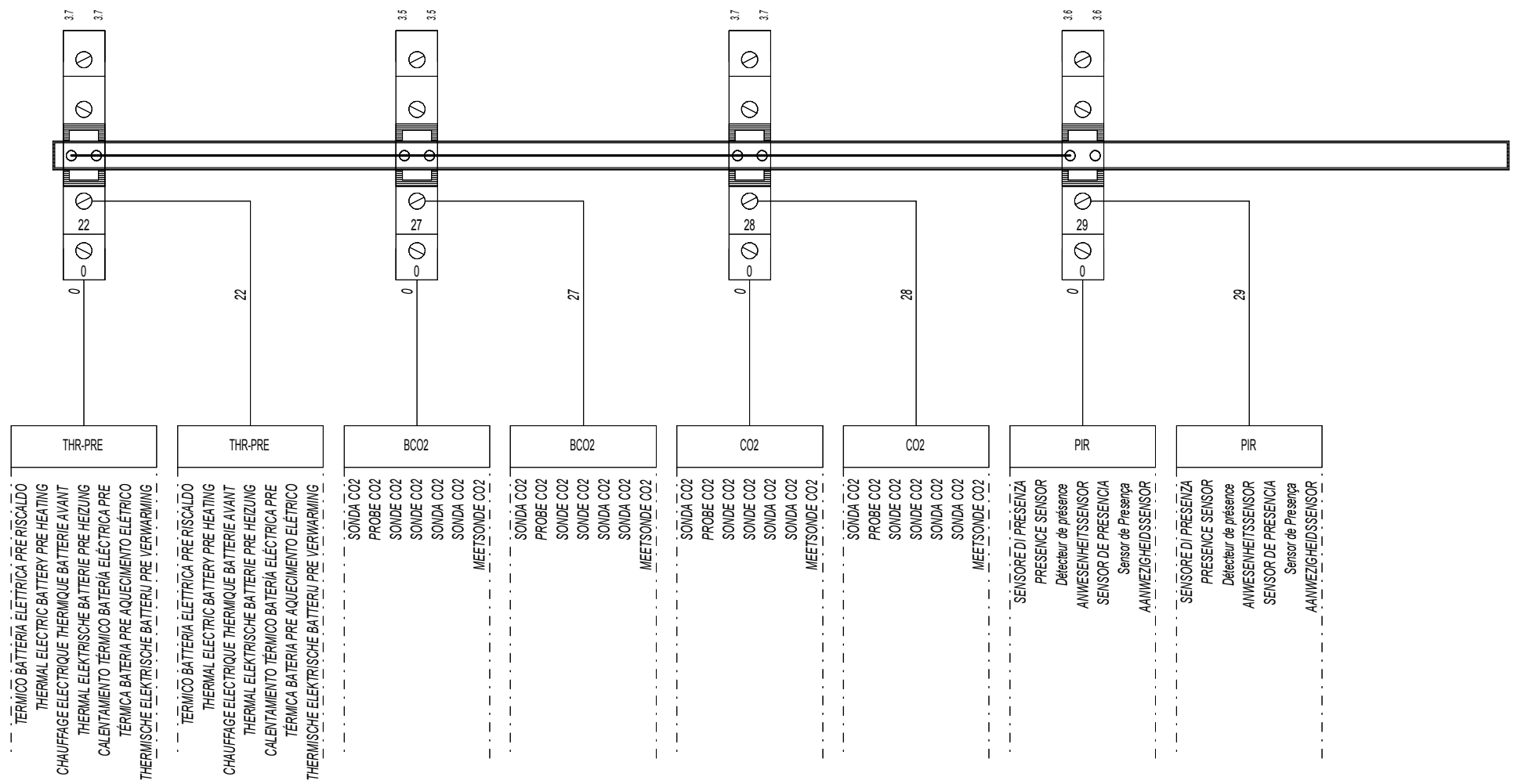

RIEPILOGO MORSETTI

AMF0006850	RKEDDB/FO/BF-RKHDDB-RKS	SHEET 11
		12 N.S.

COPYING OF THIS DOCUMENT, AND GIVING IT TO OTHERS AND THE USE OR COMMUNICATION OF THE CONTENTS THEREOF, ARE FORBIDDEN WITHOUT EXPRESS AUTHORITY. OFFENDERS ARE LIABLE TO THE PAYMENT OF DAMAGES. ALL RIGHTS ARE RESERVED IN THE EVENT OF THE GRANT OF A PATENT OF THE REGISTRATION OF A UTILITY MODEL OR DESIGN.

PROJECT: AMF0006850_03_D01M6.sch
FILE NAME
TYPE:

REVISIONS	01	03								DATE	10/12/2014
LAST REVISION DATE	10/12/2014								COMMISS.	O.Maggiolino	
SHEET STATUS	0								CHECK.		
SABIK VERSION	Ver. 18.00								APPROV.		

X1

MORSETTIERA POTENZA

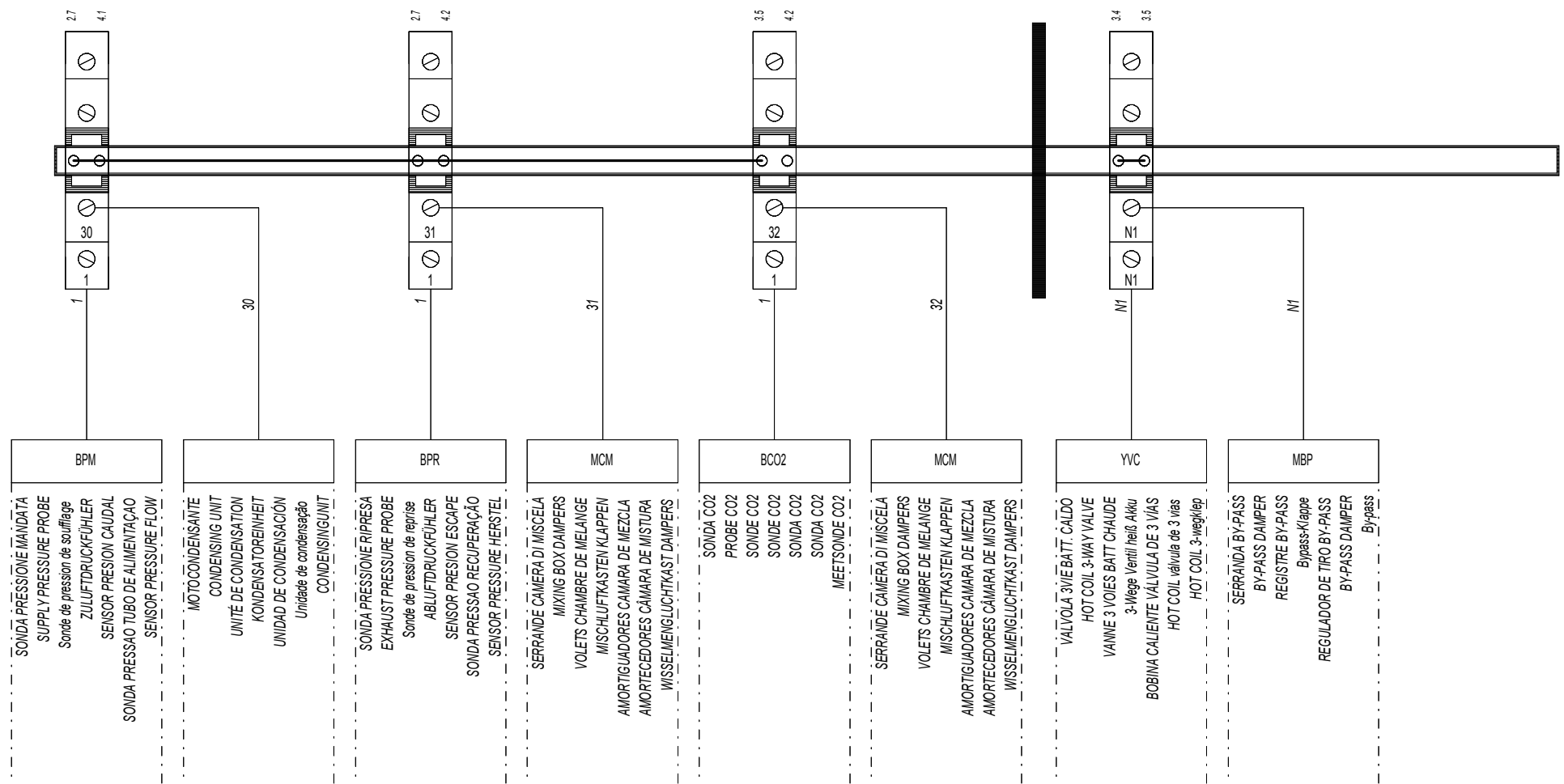

BPM
SONDA PRESSIONE MANDATA
SUPPLY PRESSURE PROBE
Sonde de pression de soufflage
ZULUFTDRUCKFÜHLER
SENSOR PRESSION CAUDAL
SONDA PRESSAO TUBO DE ALIMENTAÇÃO
SENSOR PRESSURE FLOW

MOTO CONDENSANTE
CONDENSING UNIT
UNITÉ DE CONDENSATION
KONDENSATOREINHEIT
UNIDAD DE CONDENSACIÓN
Unidade de condensação
CONDENSING UNIT

BPR
SONDA PRESSIONE RIPRESA
EXHAUST PRESSURE PROBE
Sonde de pression de reprise
ABLUFDRUCKFÜHLER
SENSOR PRESSION ESCAPE
SONDA PRESSAO RECUPERAÇÃO
SENSOR PRESSURE HERSTEL

MCM
SERRANDE CAMERA DI MISCELA
MIXING BOX DAMPERS
VOLETS CHAMBRE DE MELANGE
MISCHLUFTKASTEN KLAPPEN
AMORTIGUADORES CÁMARA DE MEZCLA
AMORTECEDORES CÁMARA DE MISTURA
WISSELMENGLUCHTKAST DAMPERS

BCO2
SONDA CO2
PROBE CO2
SONDE CO2
SONDE CO2
SONDA CO2
SONDA CO2
MEETSONDE CO2

MCM
SERRANDE CAMERA DI MISCELA
MIXING BOX DAMPERS
VOLETS CHAMBRE DE MELANGE
MISCHLUFTKASTEN KLAPPEN
AMORTIGUADORES CÁMARA DE MEZCLA
AMORTECEDORES CÁMARA DE MISTURA
WISSELMENGLUCHTKAST DAMPERS

YVC
VALVOLA 3/VE BATT. CALDO
HOT COIL 3-WAY VALVE
VANNE 3 VOIES BATT CHAUDE
3-Wege Ventil heiss Akku
BOBINA CALIENTE VÁLVULA DE 3 VÍAS
HOT COIL válvula de 3 vías
HOT COIL 3-weghelep

MBP
SERRANDA BY-PASS
BY-PASS DAMPER
REGISTRE BY-PASS
By-pass-Klappe
REGULADOR DE TIRO BY-PASS
BY-PASS DAMPER
By-pass

RIEPILOGO MORSETTI

AMF0006850

RKEDDB/FO/BF-RKHDDDB-RKS

SHEET 12
13 N.S.

COPYING OF THIS DOCUMENT, AND GIVING IT TO OTHERS AND THE USE OR COMMUNICATION OF THE CONTENTS THEREOF, ARE FORBIDDEN WITHOUT EXPRESS AUTHORITY. OFFENDERS ARE LIABLE TO THE PAYMENT OF DAMAGES. ALL RIGHTS ARE RESERVED IN THE EVENT OF THE GRANT OF A PATENT OF THE REGISTRATION OF A UTILITY MODEL OR DESIGN

PROJECT: AMF0006850_03_D01M6.sch
 FILE NAME
 TYPE:

X1

MORSETTIERA POTENZA

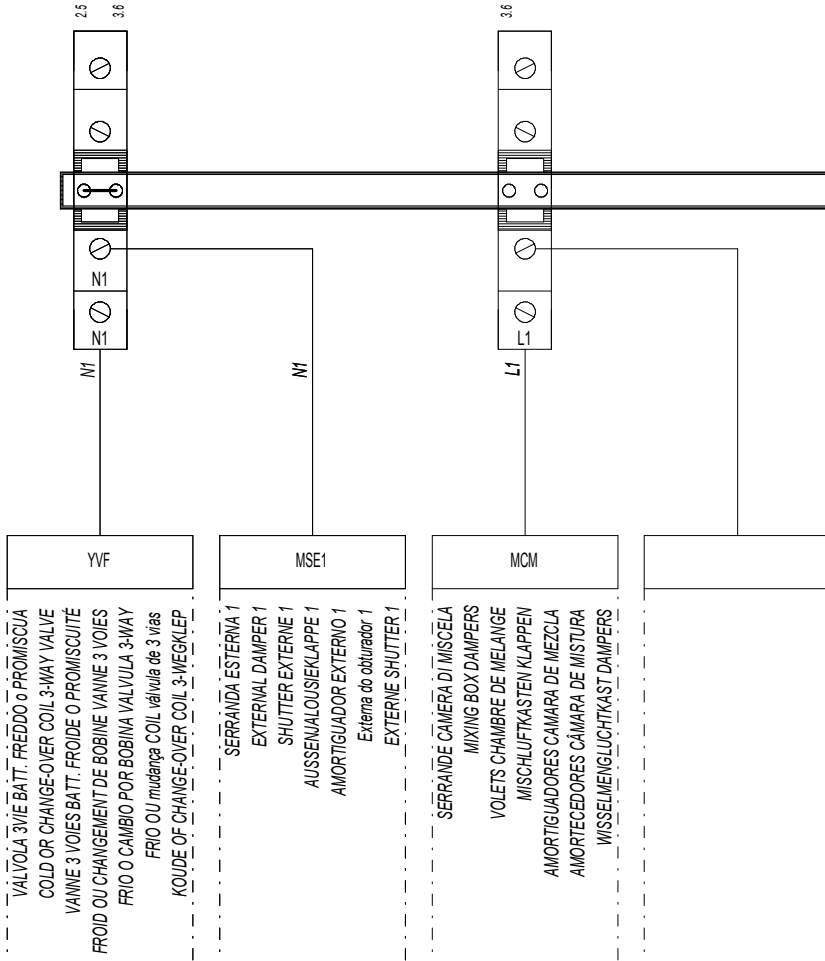

REVISIONS	03	DATE	10/12/2014	RIEPILOGO MORSETTI				=
LAST REVISION DATE	10/12/2014	COMMISS.	O.Maggiolaro					+
SHEET STATUS	0	CHECK.						SHEET 13
SABIK VERSION	Ver. 18.00	APPROV.		SUBST.:		AMF0006850	RKEDDB/FO/BF-RKHDDB-RKS	14 N.S.

COPYING OF THIS DOCUMENT, AND GIVING IT TO OTHERS AND THE USE OR COMMUNICATION OF THE CONTENTS THEREOF, ARE FORBIDDEN WITHOUT EXPRESS AUTHORITY. OFFENDERS ARE LIABLE TO THE PAYMENT OF DAMAGES. ALL RIGHTS ARE RESERVED IN THE EVENT OF THE GRANT OF A PATENT OF THE REGISTRATION OF A UTILITY MODEL OR DESIGN.

PROJECT: AMF0006850_03_D01M9.sch
 FILE NAME
 TYPE:

X3

MORSETTIERA AUSILIARI

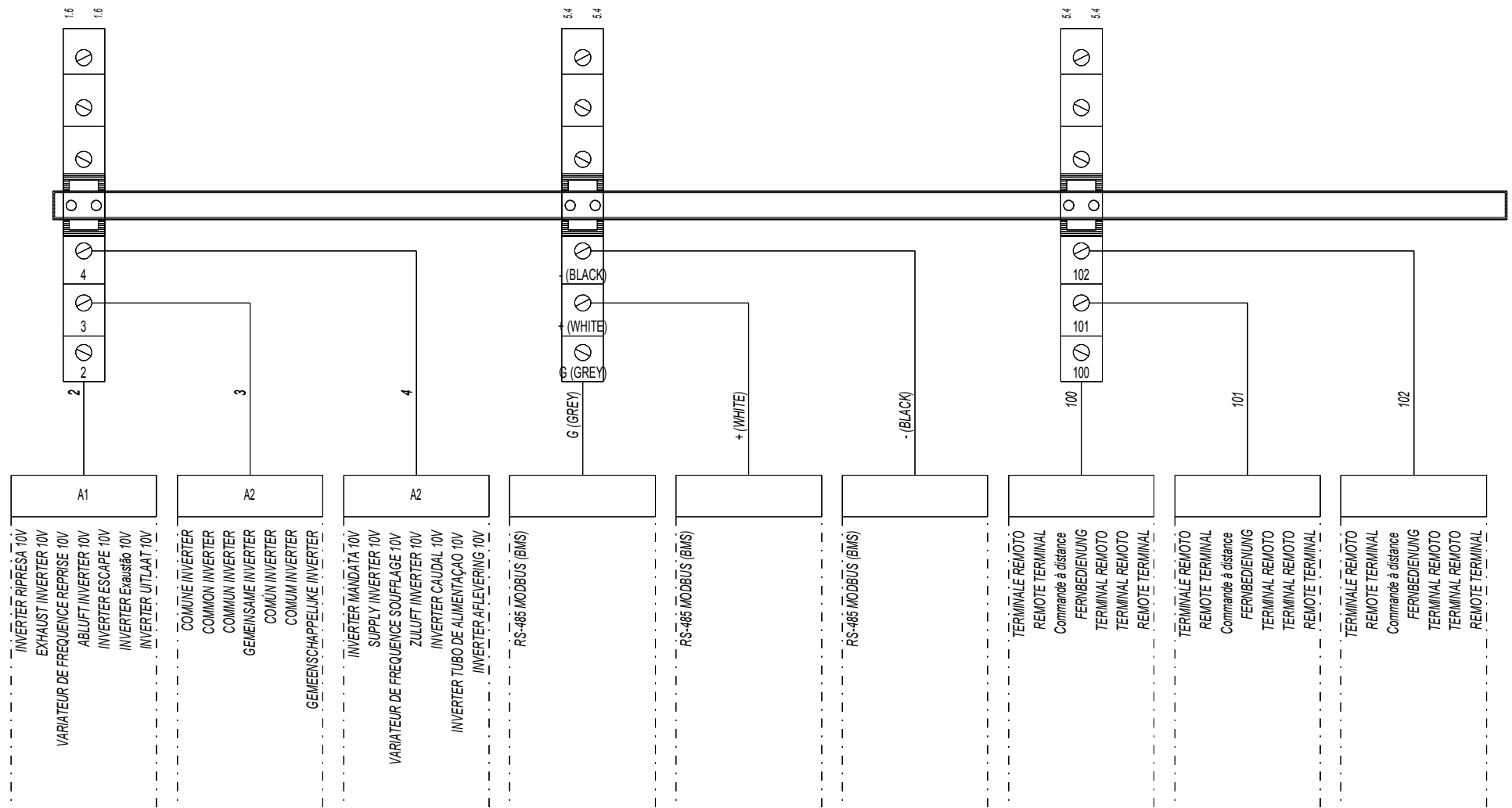

REVISIONS	01	DATE	21/05/2014	RIEPILOGO MORSETTI			
LAST REVISION DATE	21/05/2014	COMMISS.	O.Maggiolaro				
SHEET STATUS	0	CHECK.					
SABIK VERSION	Ver. 18.00	APPROV.				AMF0006850	RKEDDB/FO/BF-RKHDDB-RKS
						SHEET	14
							15 N.S.

COPYING OF THIS DOCUMENT, AND GIVING IT TO OTHERS AND THE USE OR COMMUNICATION OF THE CONTENTS THEREOF, ARE FORBIDDEN WITHOUT EXPRESS AUTHORITY. OFFENDERS ARE LIABLE TO THE PAYMENT OF DAMAGES. ALL RIGHTS ARE RESERVED IN THE EVENT OF THE GRANT OF A PATENT OF THE REGISTRATION OF A UTILITY MODEL OR DESIGN

PROJECT: AMF0006850_03_D01M6.sch
 FILE NAME
 TYPE:

X3

MORSETTIERA AUSILIARI

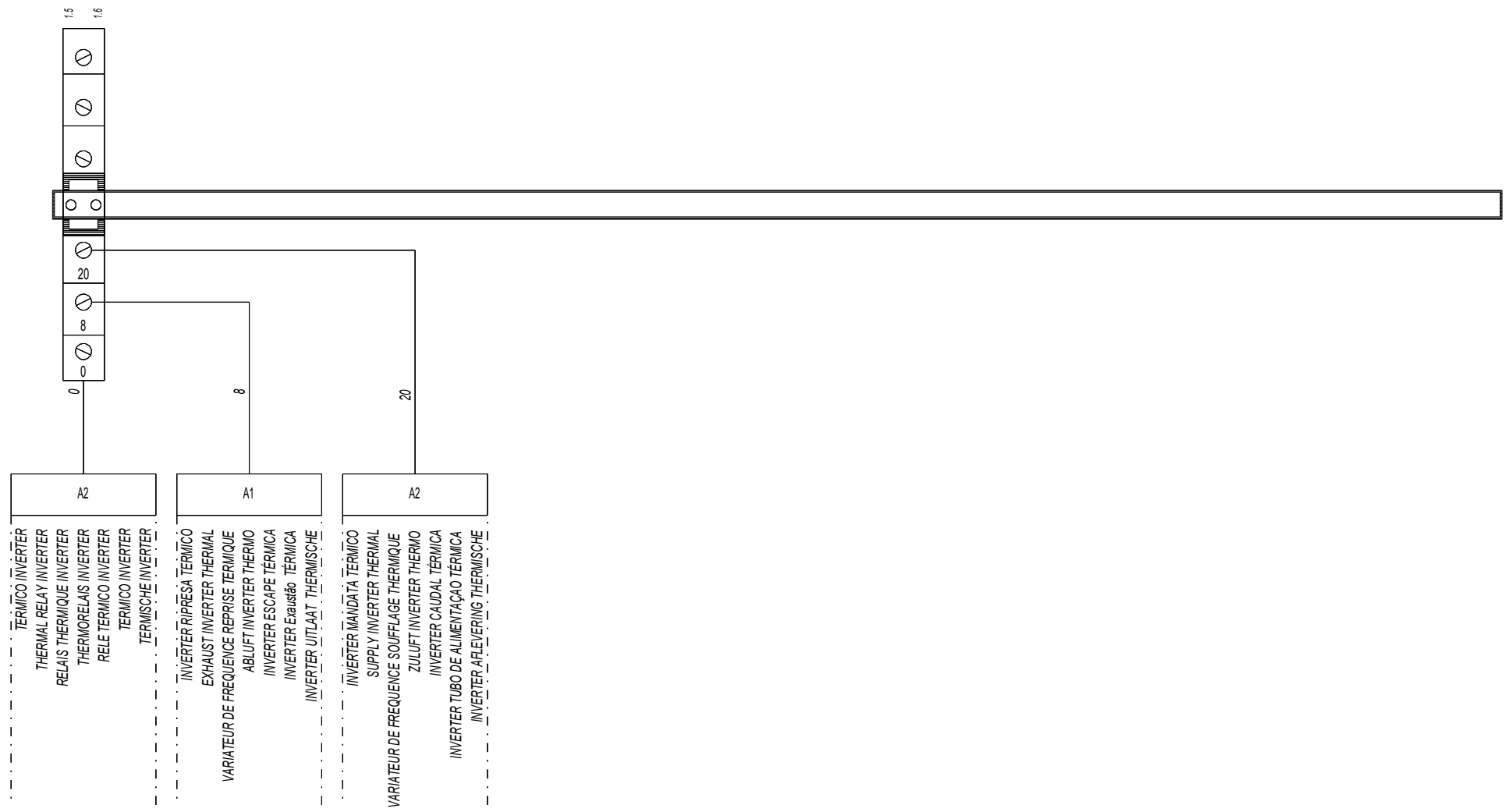

A2
 TERMICO INVERTER
 THERMAL RELAY INVERTER
 RELAIS THERMIQUE INVERTER
 THERMORELAIS INVERTER
 RELE TERMICO INVERTER
 TERMICO INVERTER
 TERMISCHE INVERTER

A1
 INVERTER RIPRESA TERMICO
 EXHAUST INVERTER THERMAL
 VARIATEUR DE FREQUENCE REPRISE THERMIQUE
 ABLUFT INVERTER THERMO
 INVERTER ESCAPE TERMICA
 INVERTER Exaustão TERMICA
 INVERTER UTTLAAT THERMISCHE

A2
 INVERTER MANDATA TERMICO
 SUPPLY INVERTER THERMAL
 VARIATEUR DE FREQUENCE SOUFLAGE THERMIQUE
 ZULUFT INVERTER THERMO
 INVERTER CAUDAL TERMICA
 INVERTER TUBO DE ALIMENTAÇÃO TERMICA
 INVERTER AFLEVERING THERMISCHE

REVISIONS	01	DATE	21/05/2014	RIEPILOGO MORSETTI		=	
LAST REVISION DATE	21/05/2014	COMMISS.	O.Maggiolaro			+	
SHEET STATUS	0	CHECK.				AMF0006850	RKEDDB/FO/BF-RKHDDDB-RKS
SABIK VERSION	Ver. 18.00	APPROV.		SUBST.:		SHEET 15	DB-001 N.S.

1	2	3	4	5	6	7	8
COMPONENTE DESIGNATION	ARTICOLO ARTICLE	DESCRIZIONE ARTICOLO ITEM DESCRIPTION	DESCRIZIONE COMPONENTE DESCRIPTION COMPONENT	COSTRUTTORE MANUFACTURER	CODICE CODE		
A1			INVERTER RIPRESA EXHAUST INVERTER VARIATEUR DE FREQUENCE REPRISE ABLUFT INVERTER INVERTER ESCAPE INVERTER Exhaustão INVERTER UITLAAT				
A2			INVERTER MANDATA SUPPLY INVERTER VARIATEUR DE FREQUENCE SOUFFLAGE ZULUFT INVERTER INVERTER CAUDAL INVERTER TUBO DE ALIMENTAÇÃO INVERTER AFLEVERING				
AI			ALLARME ANTINCENDIO FIRE ALARM ALARM ANTI-INCENDE FEUERALARME ALARMA DE INCENDIO ALARME DE INCÊNDIO BRANDALARME				
BCO2			SONDA CO2 PROBE CO2 SONDE CO2 SONDE CO2 Sonda CO2 Sonda CO2 MEETSONDE CO2				
BPM			SONDA PRESSIONE MANDATA SUPPLY PRESSURE PROBE Sonde de pression de soufflage ZULUFTDRUCKFÜHLER SENSOR PRESION CAUDAL Sonda PRESSAO TUBO DE ALIMENTAÇÃO SENSOR PRESSURE FLOW				
BPR			SONDA PRESSIONE RIPRESA EXHAUST PRESSURE PROBE Sonde de pression de reprise ABLUFTDRUCKFÜHLER SENSOR PRESION ESCAPE Sonda PRESSAO RECUPERAÇÃO SENSOR PRESSURE HERSTEL				

PROJECT: AMF0006850_03_D0106.sch
 FILE NAME
 TYPE:

REVISIONS	01							DATE	28/02/2014				=	
LAST REVISION DATE	21/05/2014			COMMISS.	OM						+			
SHEET STATUS	0			CHECK.				DISTINTA CON TRADUZIONE-PART LIST						
SABIK VERSION	Ver. 18.00			APPROV.		SUBST.:		SUB. FOR:		ORIGIN:		AMF0006850	RKEDDB/FO/BF-RKHDDDB-RKS	SHEET DB-001
														DB-002 N.S.

1	2	3	4	5	6	7	8
COMPONENTE DESIGNATION	ARTICOLO ARTICLE	DESCRIZIONE ARTICOLO ITEM DESCRIPTION	DESCRIZIONE COMPONENTE DESCRIPTION COMPONENT	COSTRUTTORE MANUFACTURER	CODICE CODE		
BTA			SONDA TEMPERATURA ANTIGELO ANTIFREEZE TEMPERATURE PROBE SONDE TEMPERATURE ANTIGEL ANTIFROST TEMPERATUR SENSOR SONDA DE TEMPERATURA DE FROST TEMPERATURA PROBE DE FROST TEMPERATUURSONDE FROST				
BTE			SONDA TEMPERATURA ESTERNA FRESH AIR TEMPERATURE SENSOR CAPTEUR DE TEMPÉRATURE AIR NEUF EXTERNER TEMPERATURSENSOR AIRE FRESCO DEL SENSOR DE TEMPERATURA SENSOR DE TEMPERATURA DO AR FRESCO VERSE LUCHT TEMPERATUURSENSOR				
BTES			SONDA TEMPERATURA ESPULSIONE EXHAUST TEMPERATURE PROBE SONDE DE TEMPERATUE EN EXPULSION Ablufttemperatur Sensor SENSOR DE TEMPERATURA EXPULSION EXPULSAO SENSOR DE TEMPERATURA UITLAAT TEMPERATUURSENSOR				
BTM			SONDA TEMPERATURA MANDATA SUPPLY AIR TEMPERATURE SENSOR CAPTEUR DE TEMPÉRATURE SOUFFLAGE ZULUFT TEMPERATUR SENSOR TEMPERATURA SENSOR DE FLUJO FORNECIMENTO SENSOR TEMPERATURA DO AR Inblaastemperaturopnemer				
FU1	3NW7053	1 PORTA FUSIBILE 10X38 1P+N	FUSIBILE FUSE FUSIBLE ABSCHMELZS. FUSIBLE FUSIVEL ZEKERING	SIEMENS	3NW7053		
1		FUSIBILE CILINDRICO 10x38 500V 16A	FUSIBILE FUSE FUSIBLE ABSCHMELZS. FUSIBLE FUSIVEL ZEKERING	SIEMENS	3NW8005-1		

PROJECT: AMF0006850_03_D0106.sch
 FILE NAME
 TYPE:

COPYING OF THIS DOCUMENT, AND GIVING IT TO OTHERS AND THE USE OR COMMUNICATION OF THE CONTENTS THEREOF, ARE FORBIDDEN WITHOUT EXPRESS AUTHORITY. OFFENDERS ARE LIABLE TO THE PAYMENT OF DAMAGES. ALL RIGHTS ARE RESERVED IN THE EVENT OF THE GRANT OF A PATENT OF THE REGISTRATION OF A UTILITY MODEL OR DESIGN.

REVISIONS	01								DATE	28/02/2014					=
LAST REVISION DATE	21/05/2014				COMMISS.	OM								+	
SHEET STATUS	0				CHECK.										
SABIK VERSION	Ver. 18.00				APPROV.					SUBST.:	SUB. FOR:		ORIGIN:		

DISTINTA CON TRADUZIONE-PART LIST

AMF0006850 RKEDDB/FO/BF-RKHDDDB-RKS SHEET DB-002
DB-003 N.S.

1	2	3	4	5	6	7	8
COMPONENTE DESIGNATION	ARTICOLO ARTICLE	DESCRIZIONE ARTICOLO ITEM DESCRIPTION	DESCRIZIONE COMPONENTE DESCRIPTION COMPONENT	COSTRUTTORE MANUFACTURER	CODICE CODE		
GD1		ALIMENTATORE DR-15-24 100-240VAC/24VDC/0.63	ALIMENTATORE C.C. D.C. POWER SUPPLY ALIMENTATION C.C. GLEICHSTROMSPEISER ALIMENTADOR C.C. ALIMENTADOR C.C. VOEDING GELIJKSTROOM	MEAN WELL	DR-15-24		
KAL		MINI RELÉ 1 CONTATTI IN SCAMBIO 12VDC 8A	RELE' ALLARME GENERALE GENERAL ALARM RELAY RELAIS ALARME GÉNÉRALE ALLGEMEINALARM- RELAY ALARMA GENERAL RELE ALARME GERAL RELÉ ALGEMEEN ALARM RELAY	SCHNEIDER	RSL1AB4JD		
1		ZOCOLO RELÉ ELETTRMECCANICO 12V AC/DC 1 SCAMBIO	RELE' ALLARME GENERALE GENERAL ALARM RELAY RELAIS ALARME GÉNÉRALE ALLGEMEINALARM- RELAY ALARMA GENERAL RELE ALARME GERAL RELÉ ALGEMEEN ALARM RELAY	SCHNEIDER	RSLZRA1		
KAMO		MINI RELÉ 1 CONTATTI IN SCAMBIO 12VDC 8A	RELE' CAMBIO MODO ESTATE INVERNO RELAY CHANGE MODE SUMMER WINTER RELAY HIVER ÉTÉ CHANGEMENT DE MODE RELAY Änderungsmodus sommer winter RELE MODO CAMBIO DE VERANO INVIERNO RELÉ MUDANÇA DE INVERNO VERÃO MODO RELAY CHANGE MODE ZOMER WINTER	SCHNEIDER	RSL1AB4JD		
1		ZOCOLO RELÉ ELETTRMECCANICO 12V AC/DC 1 SCAMBIO	RELE' CAMBIO MODO ESTATE INVERNO RELAY CHANGE MODE SUMMER WINTER RELAY HIVER ÉTÉ CHANGEMENT DE MODE RELAY Änderungsmodus sommer winter RELE MODO CAMBIO DE VERANO INVIERNO RELÉ MUDANÇA DE INVERNO VERÃO MODO RELAY CHANGE MODE ZOMER WINTER	SCHNEIDER	RSLZRA1		
KAPC		MINI RELÉ 1 CONTATTI IN SCAMBIO 12VDC 8A	RELE' POMPA CALDA RELAY PUMP HOT POMPE RELAIS HOT RELAY heiß Pumpe RELE DE LA BOMBA CALIENTE RELE DE LA BOMBA QUENTE RELAY PUMP HOT	SCHNEIDER	RSL1AB4JD		

PROJECT: AMF0006850_03_D01M6.sch
 FILE NAME: AMF0006850_03_D01M6.sch
 TYPE:

REVISIONS	01	DATE	28/02/2014	DISTINTA CON TRADUZIONE-PART LIST				=		
LAST REVISION DATE	21/05/2014	COMMISS.	OM					+		
SHEET STATUS	0	CHECK.						SHEET DB-003		
SABIK VERSION	Ver. 18.00	APPROV.		SUBST.:	SUB. FOR:	ORIGIN:	AMF0006850	RKEDDB/FO/BF-RKHDDB-RKS	SHEET DB-004	N.S.

1	2	3	4	5	6	7	8
COMPONENTE DESIGNATION	ARTICOLO ARTICLE	DESCRIZIONE ARTICOLO ITEM DESCRIPTION	DESCRIZIONE COMPONENTE DESCRIPTION COMPONENT	CONSTRUTTORE MANUFACTURER	CODICE CODE		
1		ZOCOLO RELÉ ELETTRMECCANICO 12V AC/DC 1 SCAMBIO	RELE' POMPA CALDA RELAY PUMP HOT POMPE RELAIS HOT RELAY heiß Pumpe RELE DE LA BOMBA CALIENTE RELE DE LA BOMBA QUENTE RELAY PUMP HOT	SCHNEIDER	RSLZRA1		
KAPF		MINI RELÉ 1 CONTATTI IN SCAMBIO 12VDC 8A	RELE' POMPA FREDDA O PROMISCUA RELAY PUMP COLD OR CHANGE-OVER POMPE RELAIS FROID OU PROMISCUITÉ RELAY kalt Pumpe oder promiskuitiv BOMBA DE RELE NEGATIVO O PROMISCUO BOMBA RELÉ FRIJO OU PROMISCUA RELAY POMP KOUD OF PROMISCUE	SCHNEIDER	RSL1AB4JD		
1		ZOCOLO RELÉ ELETTRMECCANICO 12V AC/DC 1 SCAMBIO	RELE' POMPA FREDDA O PROMISCUA RELAY PUMP COLD OR CHANGE-OVER POMPE RELAIS FROID OU PROMISCUITÉ RELAY kalt Pumpe oder promiskuitiv BOMBA DE RELE NEGATIVO O PROMISCUO BOMBA RELÉ FRIJO OU PROMISCUA RELAY POMP KOUD OF PROMISCUE	SCHNEIDER	RSLZRA1		
KAU		MINI RELÉ 1 CONTATTI IN SCAMBIO 12VDC 8A	RELÉ RAFFREDDAMENTO ADIABATICO RELAY COOLING ADIABATIC RELAIS REFROIDISSEMENT ADIABATIQUE ADIABATISCHE KÜHLUNG RELAY RELÉ ENFRIAMIENTO ADIABÁTICO Rele de arrefecimento adiabático RELAY KOELING ADIABATISCHE	SCHNEIDER	RSL1AB4JD		
1		ZOCOLO RELÉ ELETTRMECCANICO 12V AC/DC 1 SCAMBIO	RELÉ RAFFREDDAMENTO ADIABATICO RELAY COOLING ADIABATIC RELAIS REFROIDISSEMENT ADIABATIQUE ADIABATISCHE KÜHLUNG RELAY RELÉ ENFRIAMIENTO ADIABÁTICO Rele de arrefecimento adiabático RELAY KOELING ADIABATISCHE	SCHNEIDER	RSLZRA1		
M1			MOTORE RIPRESA MOTOR EXHAUST MOTEUR REPRISE MOTOR ABLUFT MOTOR ESCAPE MOTOR Exaustão MOTOR UITLAAT				

PROJECT: AMF0006850_03_D01M6.sch
 FILE NAME
 TYPE:
 COPYING OF THIS DOCUMENT, AND GIVING IT TO OTHERS AND THE USE OR COMMUNICATION OF THE CONTENTS THEREOF, ARE FORBIDDEN WITHOUT EXPRESS AUTHORITY. OFFENDERS ARE LIABLE TO THE PAYMENT OF DAMAGES. ALL RIGHTS ARE RESERVED IN THE EVENT OF THE GRANT OF A PATENT OF THE REGISTRATION OF A UTILITY MODEL OR DESIGN.

REVISIONS	01								DATE	28/02/2014				=
LAST REVISION DATE	21/05/2014				COMMISS.	OM							+	
SHEET STATUS	0				CHECK.					DISTINTA CON TRADUZIONE-PART LIST				
SABIK VERSION	Ver. 18.00				APPROV.								AMF0006850	
					SUBST.:	3		SUB. FOR:	4		ORIGIN:	5		RKEDDB/FO/BF-RKHDDB-RKS
										6		7		SHEET DB-004
										6		7		DB-005 N.S.

1 2 3 4 5 6 7 8

1	2	3	4	5	6	7	8
COMPONENTE DESIGNATION	ARTICOLO ARTICLE	DESCRIZIONE ARTICOLO ITEM DESCRIPTION		DESCRIZIONE COMPONENTE DESCRIPTION COMPONENT		COSTRUTTORE MANUFACTURER	CODICE CODE
M2				MOTORE MANDATA MOTOR SUPPLY MOTEUR REFOULEMENT MOTOR FORDERLEISTUNG MOTOR CAUDAL MOTOR TUBO DE ALIMENTAÇÃO MOTOR AFLEVERING			
MBP				SERRANDA BY-PASS BY-PASS DAMPER REGISTRE BY-PASS Bypass-Klappe REGULADOR DE TIRO BY-PASS BY-PASS DAMPER By-pass			
MCM				SERRANDE CAMERA DI MISCELA MIXING BOX DAMPERS VOLETS CHAMBRE DE MELANGE MISCHLUFTKASTEN KLAPPEN AMORTIGUADORES CAMARA DE MEZCLA AMORTECEDORES CÂMARA DE MISTURA WISSELMENGLUCHTKAST DAMPERS			
MSE1				SERRANDA ESTERNA 1 EXTERNAL DAMPER 1 SHUTTER EXTERNE 1 AUSSENJALOUSIEKLAPPE 1 AMORTIGUADOR EXTERNO 1 Externa do obturador 1 EXTERNE SHUTTER 1			
MSE2				SERRANDA ESTERNA 1 EXTERNAL DAMPER 1 SHUTTER EXTERNE 1 AUSSENJALOUSIEKLAPPE 1 AMORTIGUADOR EXTERNO 1 Externa do obturador 1 EXTERNE SHUTTER 1			
PSTD				PRESSOSTATO FILTRI FILTERS PRESSURE SWITCH PRESSOSTAT FILTRES FILTER DRUCKSCHALTER FILTROS DE PRESOSTATO FILTROS PRESSOSTATO FILTERS DRUKSCHAKELAAR			

COPYING OF THIS DOCUMENT, AND GIVING IT TO OTHERS AND THE USE OR COMMUNICATION OF THE CONTENTS THEREOF, ARE FORBIDDEN WITHOUT EXPRESS AUTHORITY. OFFENDERS ARE LIABLE TO THE PAYMENT OF DAMAGES. ALL RIGHTS ARE RESERVED IN THE EVENT OF THE GRANT OF A PATENT OF THE REGISTRATION OF A UTILITY MODEL OR DESIGN.

PROJECT: AMF0006850_03_D01M6.sch
 FILE NAME
 TYPE:

REVISIONS	01	DATE	28/02/2014		DISTINTA CON TRADUZIONE-PART LIST	AMF0006850	RKEDDB/FO/BF-RKHDDB-RKS	SHEET DB-005	DB-006 N.S.
LAST REVISION DATE	21/05/2014	COMMISS.	OM						
SHEET STATUS	0	CHECK.							
SABIK VERSION	Ver. 18.00	APPROV.	SUBST.:	SUB. FOR:	ORIGIN:				

1 2 3 4 5 6 7 8

COMPONENTE DESIGNATION	ARTICOLO ARTICLE	DESCRIZIONE ARTICOLO ITEM DESCRIPTION	DESCRIZIONE COMPONENTE DESCRIPTION COMPONENT	COSTRUTTORE MANUFACTURER	CODICE CODE
SH1			UMIDOSTATO HUMIDISTAT HUMIDISTAT HUMIDISTAT HUMIDISTATO UMIDOSTATO HUMIDISTAAT		
THR-POST			TERMICO BATTERIA ELETTRICA POST RISCALDO THERMAL BATTERY ELECTRIC HEATING POST THERMIQUE POST CHAUFFAGE ELECTRIQUE BATTERIE THERMAL BATTERY ELEKTROHEIZUNG POST BATERÍA TÉRMICO POSTERIOR CALEFACCIÓN ELÉCTRICA TÉRMICA BATERIA POST AQUECIMIENTO ELÉTRICO THERMISCHE BATTERIJ ELEKTRISCHE VERWARMING POST		
THR-PRE			TERMICO BATTERIA ELETTRICA PRE RISCALDO THERMAL ELECTRIC BATTERY PRE HEATING CHAUFFAGE ELECTRIQUE THERMIQUE BATTERIE AVANT THERMAL ELEKTRISCHE BATTERIE PRE HEIZUNG CALENTAMIENTO TÉRMICO BATERÍA ELÉCTRICA PRE TÉRMICA BATERIA PRE AQUECIMIENTO ELÉTRICO THERMISCHE ELEKTRISCHE BATTERIJ PRE VERWARMING		
YVC			VALVOLA 3VIE BATT. CALDO HOT COIL 3-WAY VALVE VANNE 3 VOIES BATT CHAUDE 3-Wege Ventil heiß Akku BOBINA CALIENTE VÁLVULA DE 3 VÍAS HOT COIL válvula de 3 vias HOT COIL 3-wegklep		
YVF			VALVOLA 3VIE BATT. FREDDO o PROMISCUA COLD OR CHANGE-OVER COIL 3-WAY VALVE VANNE 3 VOIES BATT. FROIDE O PROMISCUITÉ FROID OU CHANGEMENT DE BOBINE VANNE 3 VOIES FRIO O CAMBIO POR BOBINA VALVULA 3-WAY FRIO OU mudança COIL válvula de 3 vias KOUDE OF CHANGE-OVER COIL 3-WEGKLEP		
YVU			VALVOLA UMIDIFICAZIONE VALVE HUMIDIFICATION SOUPAPE HUMIDIFICATION VENTIL ANFEUCHTEN VALVULA HUMECTACION VÁLVULA HUMIDIFICAÇÃO KLEP BEVOCHTIGING		

COPYING OF THIS DOCUMENT, AND GIVING IT TO OTHERS AND THE USE OR COMMUNICATION OF THE CONTENTS THEREOF, ARE FORBIDDEN WITHOUT EXPRESS AUTHORITY. OFFENDERS ARE LIABLE TO THE PAYMENT OF DAMAGES. ALL RIGHTS ARE RESERVED IN THE EVENT OF THE GRANT OF A PATENT OF THE REGISTRATION OF A UTILITY MODEL OR DESIGN.
PROJECT: AMF0006850_03_D01M6.sch
FILE NAME
TYPE:

REVISIONS	01	DATE	28/02/2014	DISTINTA CON TRADUZIONE-PART LIST			=	
LAST REVISION DATE	21/05/2014	COMMISS.	OM				+	
SHEET STATUS	0	CHECK.					AMF0006850	RKEDDB/FO/BF-RKHDBB-RKS
SABIK VERSION	Ver. 18.00	APPROV.		SUBST.:	SUB. FOR:	ORIGIN:	SHEET DB-006	N.S.

1 2 3 4 5 6 7 8