

COPYING OF THIS DOCUMENT, AND GIVING IT TO OTHERS AND THE USE OR COMMUNICATION OF THE CONTENTS THEREOF, ARE FORBIDDEN WITHOUT EXPRESS AUTHORITY. OFFENDERS ARE LIABLE TO THE PAYMENT OF DAMAGES. ALL RIGHTS ARE RESERVED IN THE EVENT OF THE GRANT OF A PATENT OF THE REGISTRATION OF A UTILITY MODEL OR DESIGN.













RKE30-RKH30-RKS3V40

CODE

AMF0006847

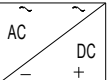
<i>RKE</i>	<i>RKH</i>	<i>RKS-3V</i>
<i>30</i>	<i>30</i>	<i>40</i>

DESIGN TYPE				DEFAULT VOLTAGE	230Vac	STANDARD	ENCLOSURE
SERIE				CONTROLS VOLTAGE	230Vac	+ UBICAZIONE = NOME LOGICO	
ORDER CODE				SIGNALS VOLTAGE	24Vcc		
CUSTOMER						POWER KW	
DESIGNED WITH CADICAE SYSTEM				Sabik		CURRENT A	
				DATE	SIGNAT.		
				COMM.	16/12/2014		
				CHECK.	16/12/2014		
				APPROV.	16/12/2014		
02	Morsetiera	16/12/2014	O.Meggiaro			SHEET 0	
01	Inserito taglio di fase	10/04/2014	OM			T.S. 23	
REV.	REVISION DESCRIPTION	DATE	COMMISS.	SUB. FOR:		SUBST.:	ORIGIN:

		1	2	3	4	5	6	7	8										
A	SIMBOLO SYMBOL		DESCRIZIONE DESCRIPTION			SIMBOLO SYMBOL		DESCRIZIONE DESCRIPTION											
			Morsetto Clamp Borne Klemme Abrazadera braçadeira klem					UMIDOSTATO HUMIDISTAT HUMIDISTAT HUMIDISTAT HUMIDISTATO UMIDOSTATO HUMIDISTAAT											
			B		Polo connettore femmina Pole female connector Connecteur femelle Pole Pole-Buchse Conector hembra Polo Conector polo feminino Polige vrouwelijke connector				Contatto NA sensibile alla pressione NO pressure switch Pressostat NO NO Druckschalter sensible a la presión de contacto NO NÃO interruptor de pressão NO drukschakelaar										
					C					Polo connettore maschio Pole male connector Connecteur mâle du pôle Pole-Stecker Conector macho Polo Pole conector macho Polige male connector				Selettore NA con comando rotativo Rotative NO switch Rotative NO interrupteur Rotative Schließer NO interruptor con mando giratorio Interruptor NÃO rotativo Rotative NO-schakelaar					
										D		Connettore femmina e maschio Pin and socket Mâle et femelle Pin und Steckdose Pin y zócalo Pin e soquete Pin en socket				Selettore NC con comando rotativo Selector switch NC Selecteur NC Wahlschalter NC Selector NC Selector NC Wahlschalter NC			
												E				Convertitore tensione AC/DC Voltage converter AC/DC Convertisseur de tension AC/DC Spannungformer AC/DC Conversor de tension AC/DC Conversor de tensao AC/DC Spanningwisselaar AC/DC			
E		Contatto NA NO contact Contact NO Kontakt schließer NO contacto NO contato maakcontact					Bobina relé Relay coil Bobine relais Relaisspule BOBINA REL bobina do relé relaispoel												
REVISIONS 01 02		DATE	16/12/2014			RIEPILOGO SIMBOLI SCHEMA			=										
LAST REVISION DATE		COMMISS.	O.Meggiolaro						+										
SHEET STATUS		CHECK.				AMF0006847		RKE30-RKH30-RKS3V40		SHEET 0-LS-01									
SABIK VERSION		APPROV.	SUBST.:							0-LS-02 N.S.									

COPYING OF THIS DOCUMENT, AND GIVING IT TO OTHERS AND THE USE OR COMMUNICATION OF THE CONTENTS THEREOF, ARE FORBIDDEN WITHOUT EXPRESS AUTHORITY. OFFENDERS ARE LIABLE TO THE PAYMENT OF DAMAGES. ALL RIGHTS ARE RESERVED IN THE EVENT OF THE GRANT OF A PATENT OF THE REGISTRATION OF A UTILITY MODEL OR DESIGN.

PROJECT: AMF0006847_02.sch
 FILE NAME
 TYPE:

A

SIMBOLO
SYMBOL

DESCRIZIONE
DESCRIPTION

SIMBOLO
SYMBOL

DESCRIZIONE
DESCRIPTION

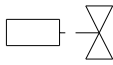

Elettrovalvola aperta
Solenoid valve open
Électrovanne ouverte
Magnetventil offen
Solenoido de la válvula abierta
Válvula solenóide aberto
Solenoid klep open



Sonda Temperatura
Temperature Sensor
Capteur de température
Temperatur-Sensor
Sensor de temperatura
Sensor de Temperatura
temperatursensor

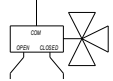

Valvola 3 vie comando 3 punti
3-way valve with 3-point servomotor
Vanne 3-voies avec servomoteur à 3-points
3-Wege-Ventil mit 3-Punkt-Stellantrieb
Válvula de 3 vías con servomotor 3-puntos
3-way válvula com 3 pontos servomotor
3-wegklep met 3-punts servomotor



Trasduttore di Pressione
Pressure Transducer
Capteur de pression
Druckaufnehmer
Transductor de presión
Transdutor de Pressão
Pressure Transducer

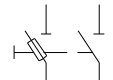

Sezionatore bipolare con fusibili
2Pole disconnecting switch with fuses
Sectionneur 2P avec fusibles
2Poling isolator mit sicherungen
Interruptor 2pole con fusibles
Seccionador 2pole com fusivel
2Pole ontleder met zekeringen



Servomote
SERVOMOTOR
SERVOMOTEUR
SERVOMOTEUR
ACTUADOR
ATUADOR
ACTUATOR

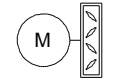

Servomote
SERVOMOTOR
SERVOMOTEUR
SERVOMOTEUR
ACTUADOR
ATUADOR
ACTUATOR

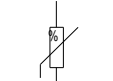

Sonda CO2
PROBE CO2
SONDE CO2
SONDE CO2
SONDA CO2
SONDA CO2
MEETSONDE CO2

A

B

C

D

E

COPYING OF THIS DOCUMENT, AND GIVING IT TO OTHERS AND THE USE OR COMMUNICATION OF THE CONTENTS THEREOF, ARE FORBIDDEN WITHOUT EXPRESS AUTHORITY. OFFENDERS ARE LIABLE TO THE PAYMENT OF DAMAGES. ALL RIGHTS ARE RESERVED IN THE EVENT OF THE GRANT OF A PATENT OF THE REGISTRATION OF A UTILITY MODEL OR DESIGN.

PROJECT: AMF0006847_02.sch
FILE NAME:
TYPE:

F

REVISIONS	01	02									DATE	16/12/2014	
LAST REVISION DATE	16/12/2014								COMMISS.	O.Meggiolaro			
SHEET STATUS	0								CHECK.				
SABIK VERSION	Ver. 18.00		APPROV.		SUBST.:		SUB. FOR:		ORIGIN:				

RIEPILOGO SIMBOLI SCHEMA
SYMBOLS SUMMARY

AMF0006847		RKE30-RKH30-RKS3V40		SHEET	0-LS-02
				1	N.S.

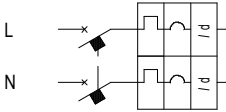

230Vac 1Ph 50Hz +N

LINEA ALIMENTAZIONE :
PREDISPORRE A MONTE
UNA ADEGUATA PROTEZIONE
CON INTERRUITTORE
MAGNETOTERMICO
DIFFERENZIALE

POWER LINE:
 PROVIDE A PROPER PROTECTION
 WITH DIFFERENTIAL
 MAGNETOTHERMAL SWITCH

LIGNE D' ALIMENTATION:
PRÉPAREZ-VOUS À MONTER
UNE PROTECTION ADEQUATE
AVEC INTERRUPTEUR THERMIQUE
DIFFERENTIEL

STROMLEITUNG:
 BEREITEN SIE VOR
 ANGEMESSENEN SCHUTZ
 MIT SCHALTER
 magnetothermischen
 DIFFERENTIAL

SUMINISTRO DE LÍNEA:
 PREPARARSE PARA MONTAR
 UN INTERRUPTOR DE CIRCUITO
 DE PROTECCIÓN ADECUADA

POWER LINE:
 FORNECER:
 uma proteção adequada
 com diferencial opção
 magnetothermal

POWER LINE:
 BIEDEN:
 EEN GOEDE BESCHERMING
 WITH DIFFERENTIEEL
 MAGNETOTHERMAL SCHAKELAAR

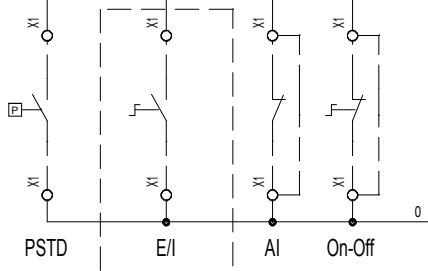
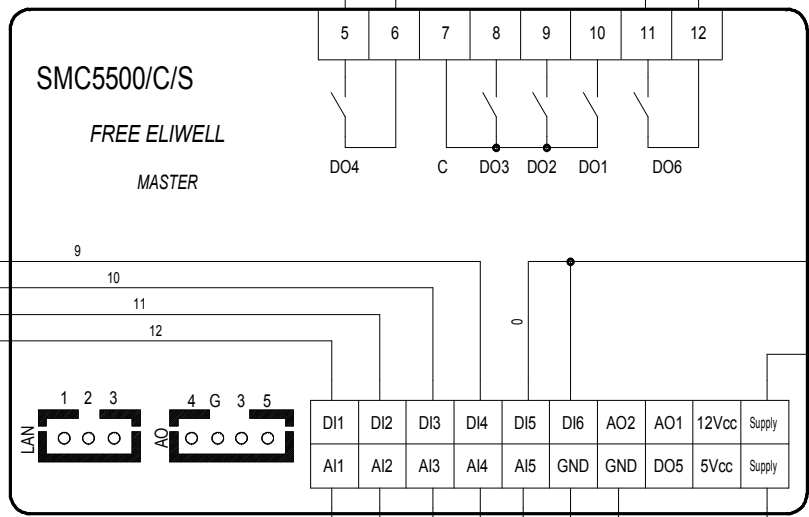
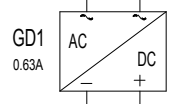
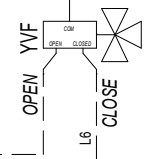
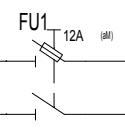

APERTO
 OPEN
 OUVERT
 OFFEN
 ABIERTO
 ABERTO
 OPEN

FREDDO
 COLD
 FROID
 KALT
 FRIO
 FRIO
 KÖLD

COPYING OF THIS DOCUMENT, AND GIVING IT TO OTHERS AND THE USE OR COMMUNICATION OF THE CONTENTS THEREOF, ARE FORBIDDEN WITHOUT EXPRESS AUTHORITY. OFFENDERS ARE LIABLE TO THE PAYMENT OF DAMAGES. ALL RIGHTS ARE RESERVED IN THE EVENT OF THE GRANT OF A PATENT OF THE REGISTRATION OF A UTILITY MODEL OR DESIGN.

PROJECT: AMF0006847_02.scd
 FILE NAME
 TYPE:

REVISIONS	01	02											DATE	16/12/2014															
LAST REVISION DATE	16/12/2014			COMMISS.			O.Meggiolaro																						
SHEET STATUS	0			CHECK.												SHEET 1													
SABIK VERSION	Ver. 18.00			APPROV.						SUBST.:			SUB. FOR:			ORIGIN:													
										MASTER																			
										AMF0006847										RKE30-RKH30-RKS3V40									
																				3									
																				N.S.									

COPYING OF THIS DOCUMENT, AND GIVING IT TO OTHERS AND THE USE OR COMMUNICATION OF THE CONTENTS THEREOF, ARE FORBIDDEN WITHOUT EXPRESS AUTHORITY. OFFENDERS ARE LIABLE TO THE PAYMENT OF DAMAGES. ALL RIGHTS ARE RESERVED IN THE EVENT OF THE GRANT OF A PATENT OF THE REGISTRATION OF A UTILITY MODEL OR DESIGN.

PROJECT: AMF0006847_02.sch
 FILE NAME
 TYPE:

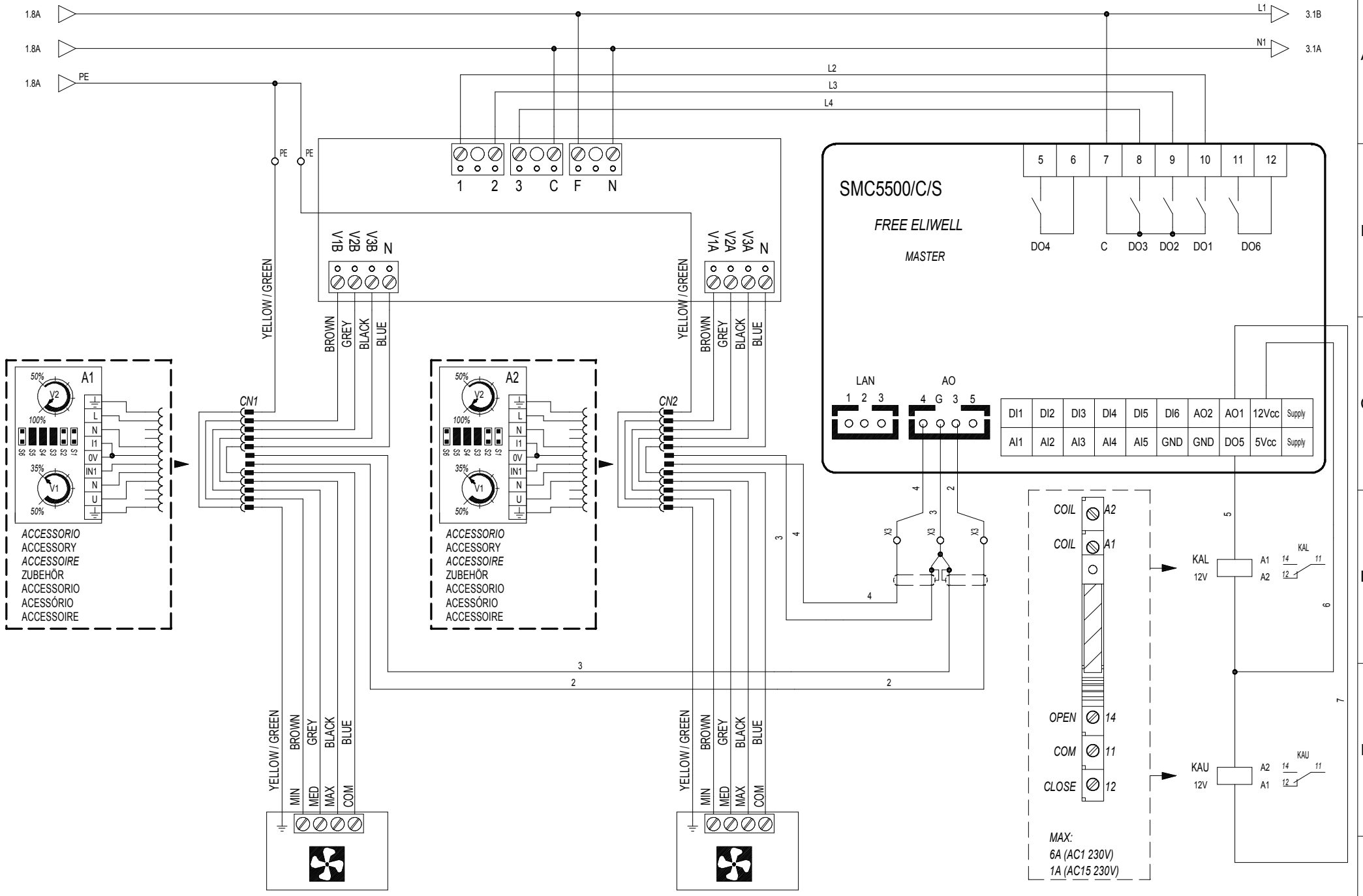

REVISIONS	01 02	DATE	24/04/2014	MASTER FANS		AMF0006847	RKE30-RKH30-RKS3V40	SHEET 3
LAST REVISION DATE	16/12/2014	COMMISS.	O.Meggiolaro					4 N.S.
SHEET STATUS	0	CHECK.						
SABIK VERSION	Ver. 18.00	APPROV.		Subst.:	Sub. For:			

COPYING OF THIS DOCUMENT, AND GIVING IT TO OTHERS AND THE USE OR COMMUNICATION OF THE CONTENTS THEREOF, ARE FORBIDDEN WITHOUT EXPRESS AUTHORITY. OFFENDERS ARE LIABLE TO THE PAYMENT OF DAMAGES. ALL RIGHTS ARE RESERVED IN THE EVENT OF THE GRANT OF A PATENT OF A UTILITY MODEL OR DESIGN.

PROJECT: AMF0006847_02.sch
 FILE NAME
 TYPE:

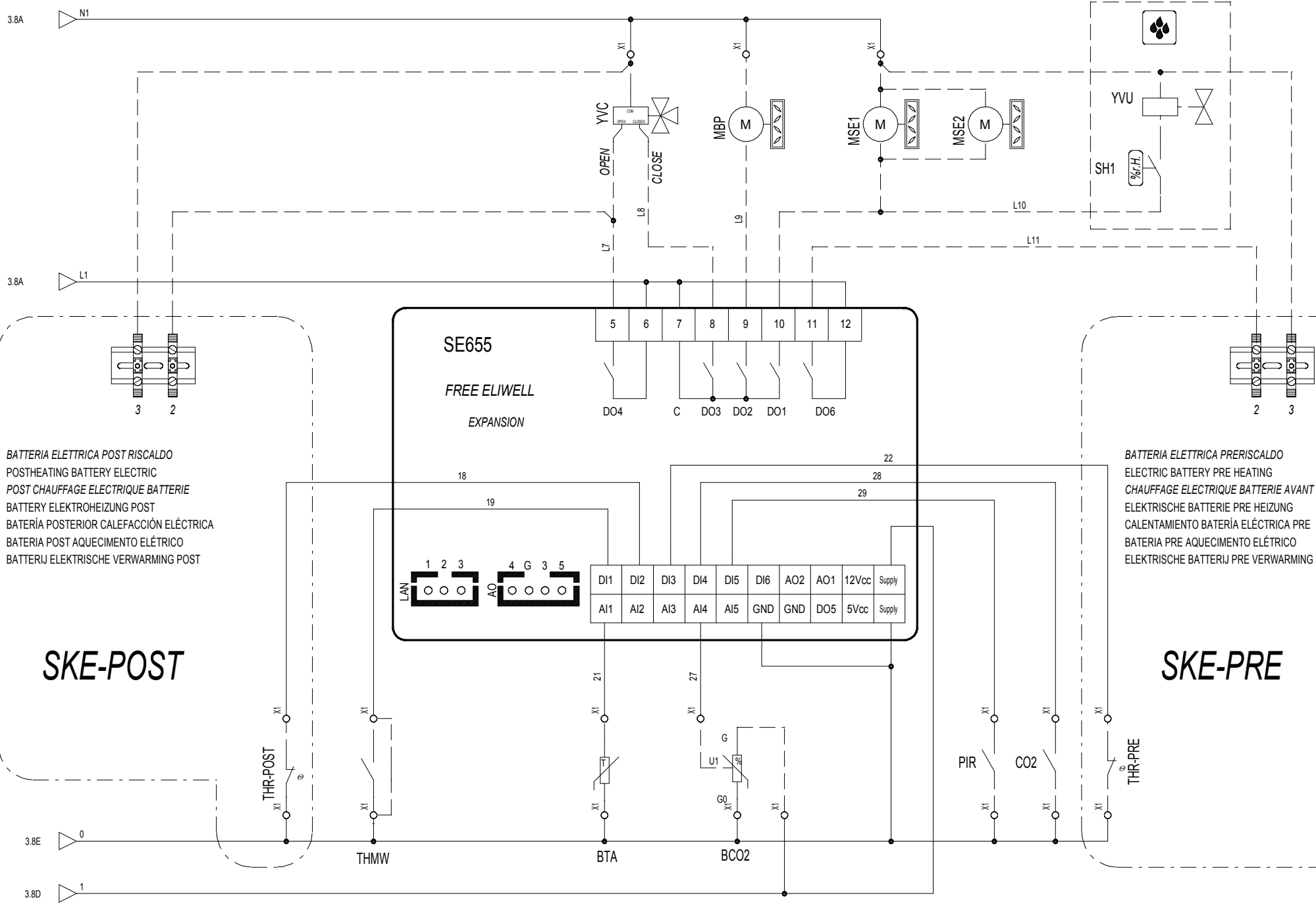

REVISIONS	01 02	DATE	16/12/2014		EXPANSION			=	
LAST REVISION DATE	16/12/2014	COMMISS.	O.Meggiolaro					+	
SHEET STATUS	0	CHECK.						SHEET 4	
SABIK VERSION	Ver. 18.00	APPROV.	SUBST.:	SUB. FOR:	ORIGIN:	AMF0006847	RKE30-RKH30-RKS3V40	SHEET	5 N.S.

PROJECT: AMF0006847_02.sch
 FILE NAME
 TYPE:
 COPYING OF THIS DOCUMENT, AND GIVING IT TO OTHERS AND THE USE OR COMMUNICATION OF THE CONTENTS THEREOF, ARE FORBIDDEN WITHOUT EXPRESS AUTHORITY. OFFENDERS ARE LIABLE TO THE PAYMENT OF DAMAGES. ALL RIGHTS ARE RESERVED IN THE EVENT OF THE GRANT OF A PATENT OF THE REGISTRATION OF A UTILITY MODEL OR DESIGN.

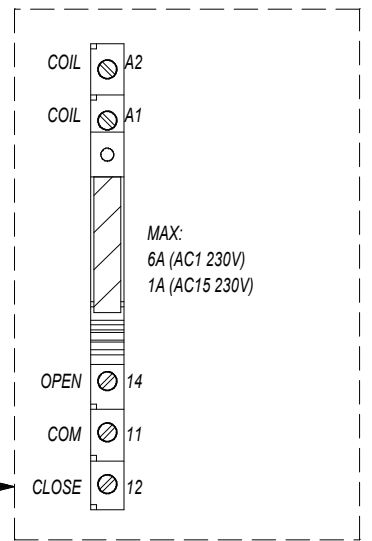
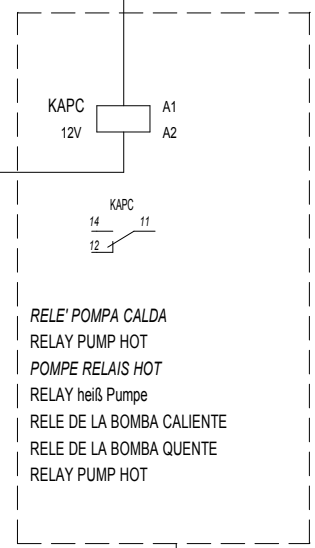
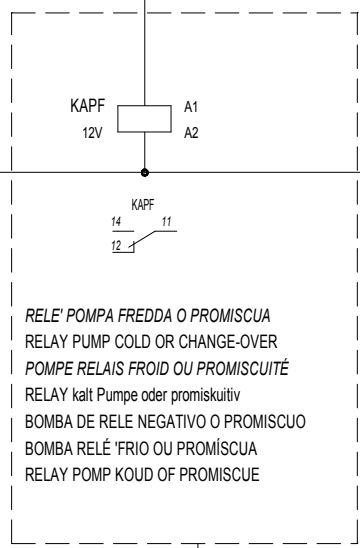
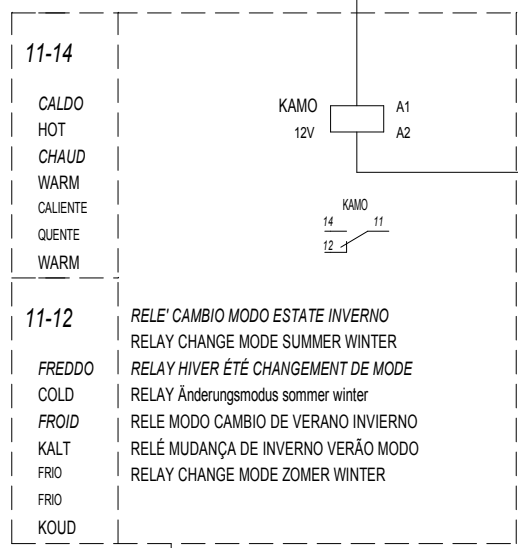
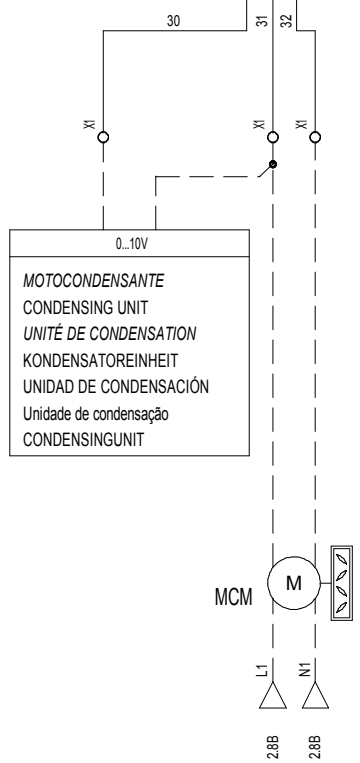
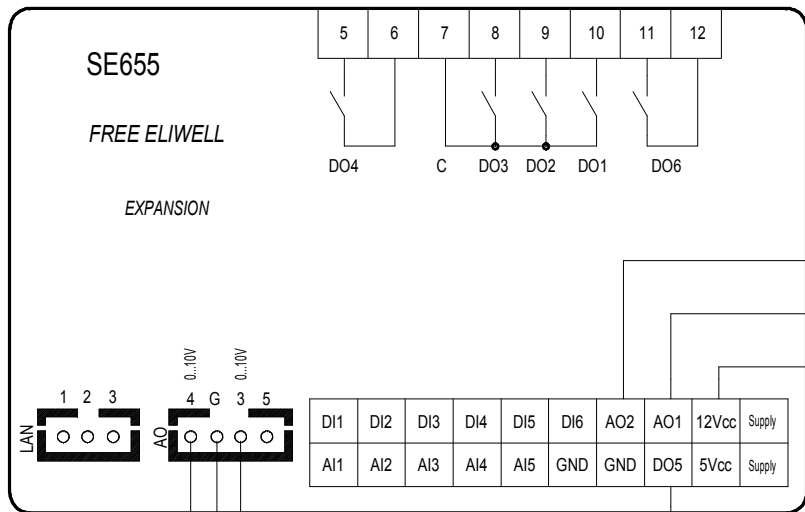

REVISIONS	01 02	DATE	16/12/2014	EXPANSION RELAY		AMF0006847	RKE30-RKH30-RKS3V40	SHEET 5
LAST REVISION DATE	16/12/2014	COMMISS.	O.Meggiolaro					6 N.S.
SHEET STATUS	0	CHECK.						
SABIK VERSION	Ver. 18.00	APPROV.		SUBST.:	SUB. FOR:	ORIGIN:		

PROJECT: AMF0006847_02.sch
 FILE NAME
 TYPE:
 COPYING OF THIS DOCUMENT, AND GIVING IT TO OTHERS AND THE USE OR COMMUNICATION OF THE CONTENTS THEREOF, ARE FORBIDDEN WITHOUT EXPRESS AUTHORITY. OFFENDERS ARE LIABLE TO THE PAYMENT OF DAMAGES. ALL RIGHTS ARE RESERVED IN THE EVENT OF THE GRANT OF A PATENT OF THE REGISTRATION OF A UTILITY MODEL OR DESIGN.

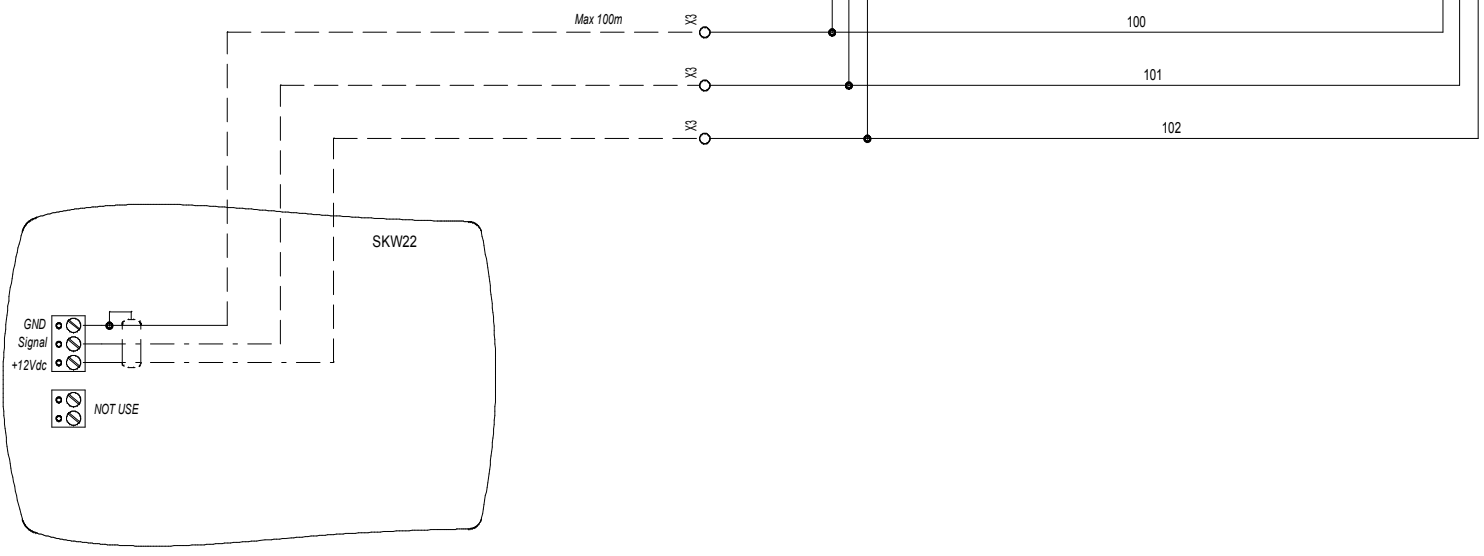
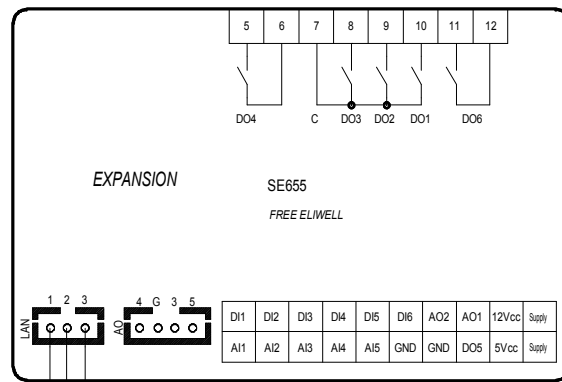
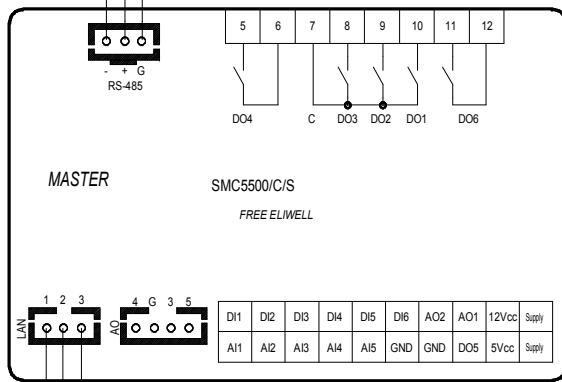
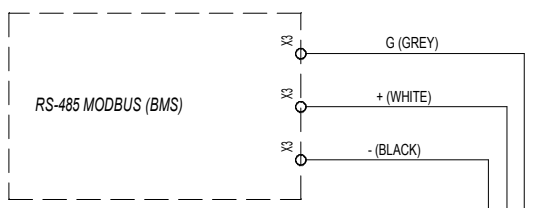

REVISIONS	01										DATE	11/07/2013	
LAST REVISION DATE	10/04/2014								COMMISS.	OM			
SHEET STATUS	0								CHECK.				
SABIK VERSION	Ver. 18.00		APPROV.			SUBST.:	SUB. FOR:		ORIGIN:				

TERMINALE															
										AMF0006847		RKE30-RKH30-RKS3V40		SHEET 6	
														7 N.S.	

COPYING OF THIS DOCUMENT, AND GIVING IT TO OTHERS AND THE USE OR COMMUNICATION OF THE CONTENTS THEREOF, ARE FORBIDDEN WITHOUT EXPRESS AUTHORITY. OFFENDERS ARE LIABLE TO THE PAYMENT OF DAMAGES. ALL RIGHTS ARE RESERVED IN THE EVENT OF THE GRANT OF A PATENT OF THE REGISTRATION OF A UTILITY MODEL OR DESIGN.

PROJECT: AMF0006847_02.sch
 FILE NAME
 TYPE:

REVISIONS	01	02									DATE	16/12/2014
LAST REVISION DATE	16/12/2014		COMMISS.		O.Meggiolaro							
SHEET STATUS	0		CHECK.									
SABIK VERSION	Ver. 18.00		APPROV.									

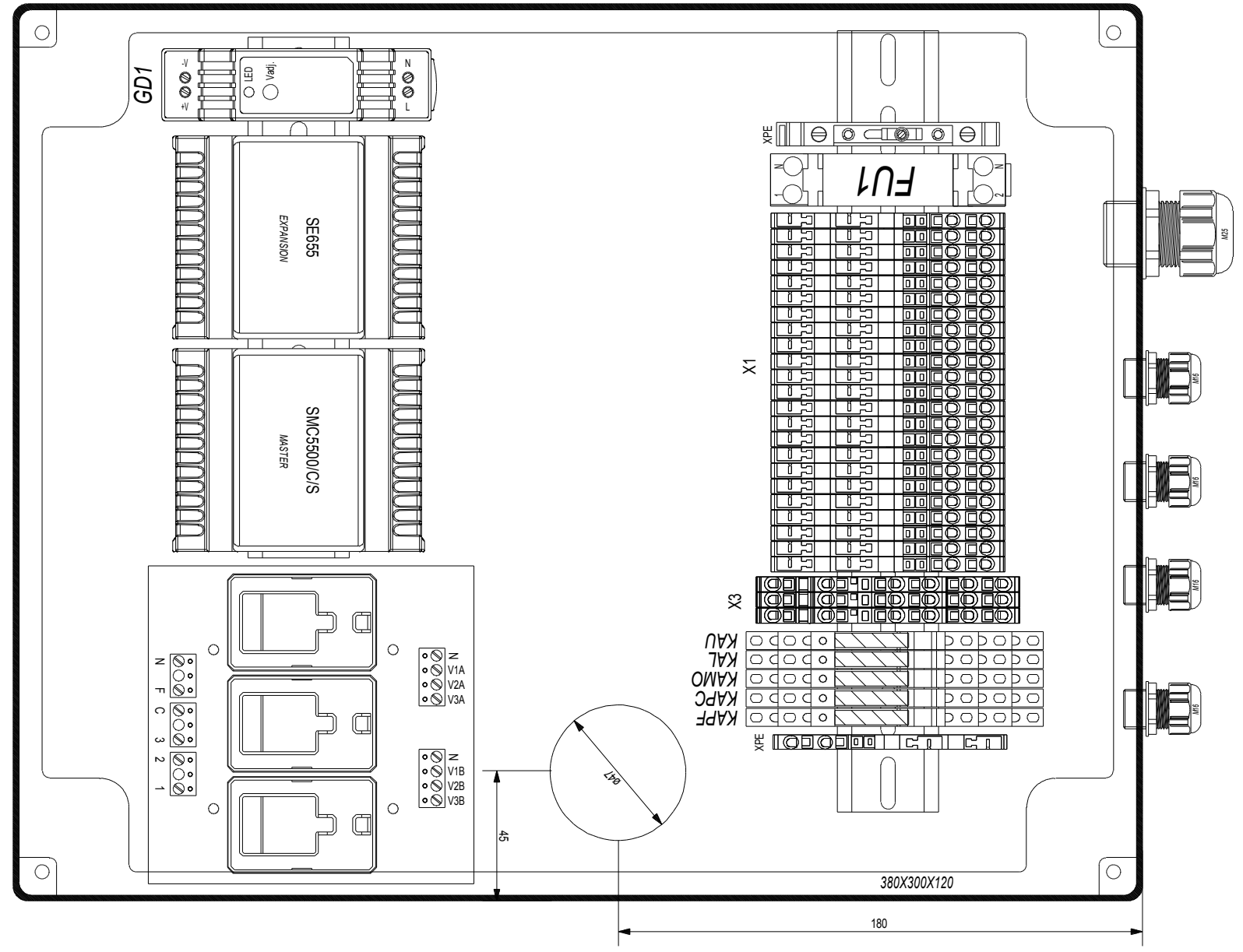

LAYOUT

COPYING OF THIS DOCUMENT, AND GIVING IT TO OTHERS AND THE USE OR COMMUNICATION OF THE CONTENTS THEREOF, ARE FORBIDDEN WITHOUT EXPRESS AUTHORITY. OFFENDERS ARE LIABLE TO THE PAYMENT OF DAMAGES. ALL RIGHTS ARE RESERVED IN THE EVENT OF THE GRANT OF A PATENT OF A UTILITY MODEL OR DESIGN.

XPE

MORSETTIERA POTENZA PE

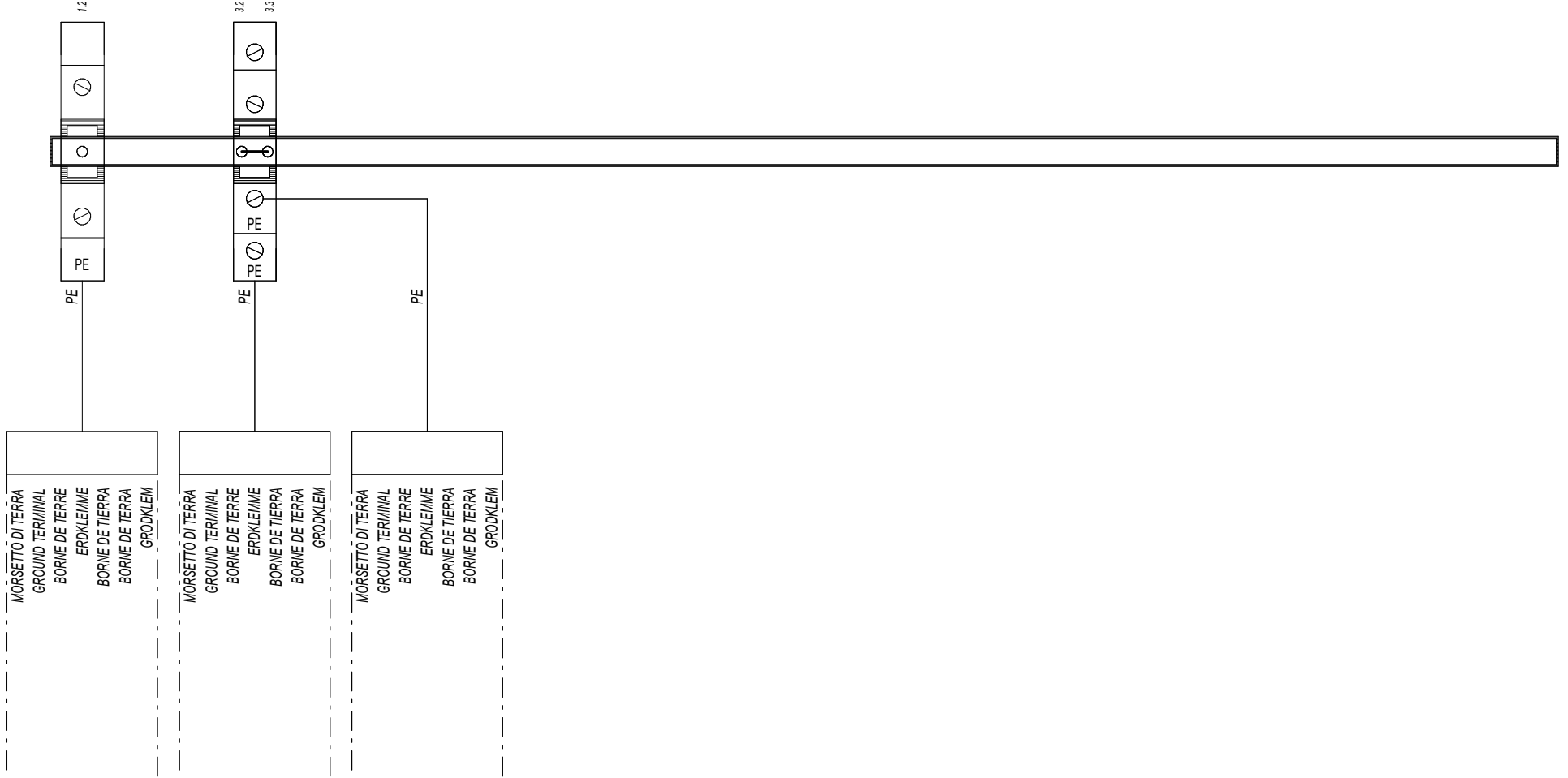

PROJECT:
 FILE NAME: AMF0006847_02.scp
 TYPE:

REVISIONS	01	02					DATE	16/12/2014				=
LAST REVISION DATE	16/12/2014		COMMISS.	O.Meggiolaro						RIEPILOGO MORSETTI		+
SHEET STATUS	0		CHECK.									SHEET 8
SABIK VERSION	Ver. 18.00		APPROV.			Subst.:	SUB. FOR:		ORIGIN:	AMF0006847	RKE30-RKH30-RKS3V40	9 N.S.

COPYING OF THIS DOCUMENT, AND GIVING IT TO OTHERS AND THE USE OR COMMUNICATION OF THE CONTENTS THEREOF, ARE FORBIDDEN WITHOUT EXPRESS AUTHORITY. OFFENDERS ARE LIABLE TO THE PAYMENT OF DAMAGES. ALL RIGHTS ARE RESERVED IN THE EVENT OF THE GRANT OF A PATENT OF THE REGISTRATION OF A UTILITY MODEL OR DESIGN.

PROJECT: AMF0006847_02.sch
FILE NAME
TYPE:

REVISIONS	01	02								DATE	16/12/2014
LAST REVISION DATE	16/12/2014								COMMISS.	O.Meggiolaro	
SHEET STATUS	0								CHECK.		
SABIK VERSION	Ver. 18.00								APPROV.		

MORSETTIERA POTENZA X1

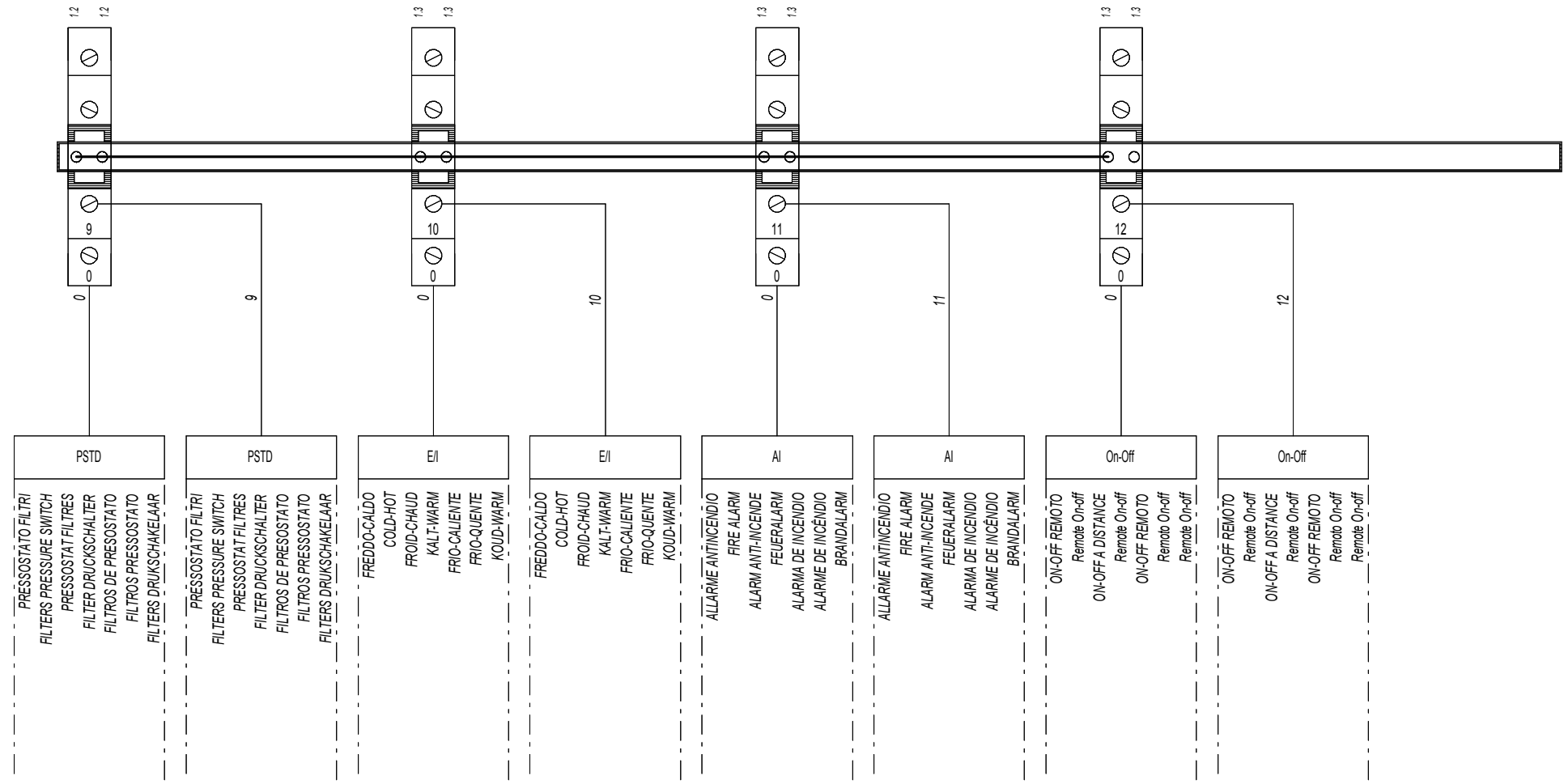

PSTD
 PRESSOSTATO FILTRI
 FILTERS PRESSURE SWITCH
 PRESSOSTAT FILTRES
 FILTER DRUCKSCHALTER
 FILTROS DE PRESSOSTATO
 FILTROS PRESSOSTATO
 FILTERS DRUKSCHAKELAAR

PSTD
 PRESSOSTATO FILTRI
 FILTERS PRESSURE SWITCH
 PRESSOSTAT FILTRES
 FILTER DRUCKSCHALTER
 FILTROS DE PRESSOSTATO
 FILTROS PRESSOSTATO
 FILTERS DRUKSCHAKELAAR

E/I
 FREDDO-CALDO
 COLD-HOT
 FROID-CHAUD
 KALT-WARM
 FRIO-CALENTE
 FRIO-QUENTE
 KOUD-WARM

E/I
 FREDDO-CALDO
 COLD-HOT
 FROID-CHAUD
 KALT-WARM
 FRIO-CALENTE
 FRIO-QUENTE
 KOUD-WARM

AI
 ALLARME ANTINCENDIO
 FIRE ALARM
 ALARM ANTI-INCENDE
 FEUERALARIM
 ALARMA DE INCENDIO
 ALARME DE INCENDIO
 BRANDALARIM

AI
 ALLARME ANTINCENDIO
 FIRE ALARM
 ALARM ANTI-INCENDE
 FEUERALARIM
 ALARMA DE INCENDIO
 ALARME DE INCENDIO
 BRANDALARIM

On-Off
 ON-OFF REMOTO
 Remote On-off
 ON-OFF A DISTANCE
 Remote On-off
 ON-OFF REMOTO
 Remote On-off
 Remote On-off

On-Off
 ON-OFF REMOTO
 Remote On-off
 ON-OFF A DISTANCE
 Remote On-off
 ON-OFF REMOTO
 Remote On-off
 Remote On-off

RIEPILOGO MORSETTI

COPYING OF THIS DOCUMENT, AND GIVING IT TO OTHERS AND THE USE OR COMMUNICATION OF THE CONTENTS THEREOF, ARE FORBIDDEN WITHOUT EXPRESS AUTHORITY. OFFENDERS ARE LIABLE TO THE PAYMENT OF DAMAGES. ALL RIGHTS ARE RESERVED IN THE EVENT OF THE GRANT OF A PATENT OF THE REGISTRATION OF A UTILITY MODEL OR DESIGN.

PROJECT: AMF0006847_02.sch
 FILE NAME
 TYPE:

X1

MORSETTIERA POTENZA

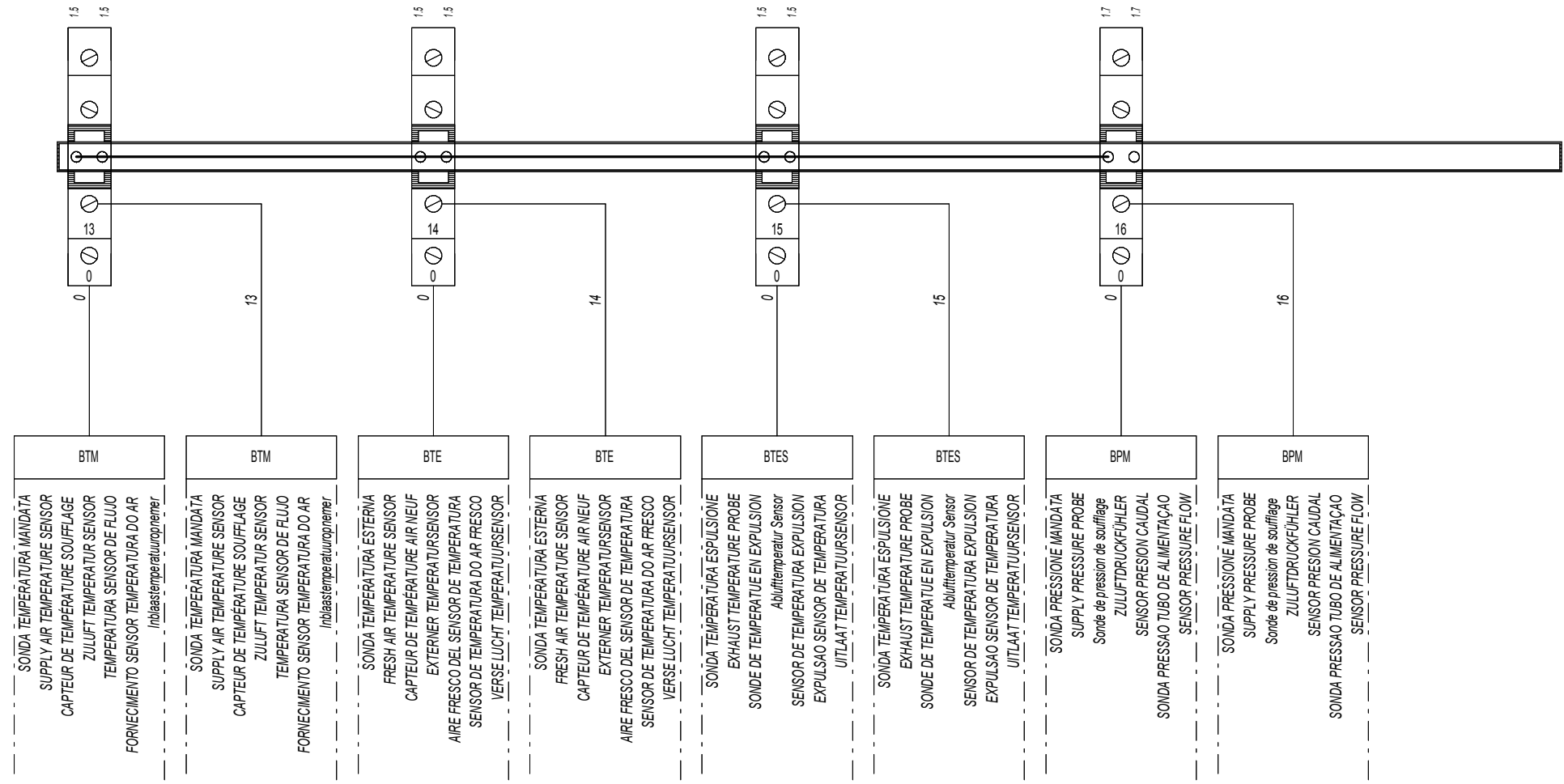

REVISIONS	01	02								DATE	16/12/2014
LAST REVISION DATE	16/12/2014									COMMISS.	O. Meggiolaro
SHEET STATUS	0									CHECK.	
SABIK VERSION	Ver. 18.00									APPROV.	

PROJECT	RIEPILOGO MORSETTI									
DESCRIPTION										
DESIGNER										
CHECKED										
DATE										
SCALE										
SUBST.										
SUB. FOR.										
ORIGIN:										

PROJECT	AMF0006847	RKE30-RKH30-RKS3V40	SHEET	10
DATE				11
SCALE				N.S.

COPYING OF THIS DOCUMENT, AND GIVING IT TO OTHERS AND THE USE OR COMMUNICATION OF THE CONTENTS THEREOF, ARE FORBIDDEN WITHOUT EXPRESS AUTHORITY. OFFENDERS ARE LIABLE TO THE PAYMENT OF DAMAGES. ALL RIGHTS ARE RESERVED IN THE EVENT OF THE GRANT OF A PATENT OF THE REGISTRATION OF A UTILITY MODEL OR DESIGN.

PROJECT: AMF0006847_02.sch
FILE NAME
TYPE:

MORSETTIERA POTENZA X1

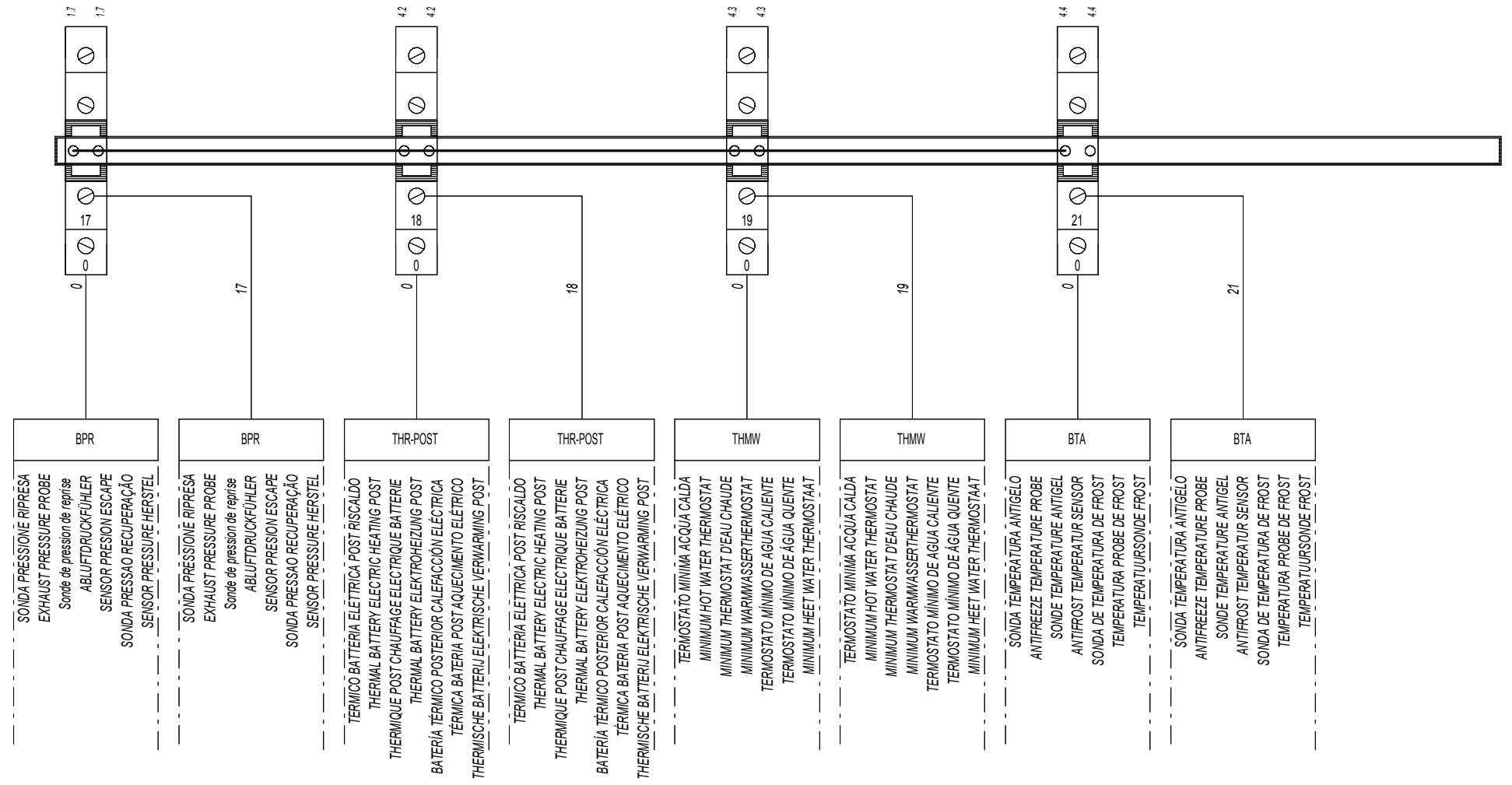

REVISIONS	01	02								DATE	16/12/2014
LAST REVISION DATE	16/12/2014								COMMISS.	O.Meggiolaro	
SHEET STATUS	0								CHECK.		
SABIK VERSION	Ver. 18.00								APPROV.		

RIEPILOGO MORSETTI										=
										+
										AMF0006847
										RKE30-RKH30-RKS3V40
										SHEET 11
										12 N.S.

COPYING OF THIS DOCUMENT, AND GIVING IT TO OTHERS AND THE USE OR COMMUNICATION OF THE CONTENTS THEREOF, ARE FORBIDDEN WITHOUT EXPRESS AUTHORITY. OFFENDERS ARE LIABLE TO THE PAYMENT OF DAMAGES. ALL RIGHTS ARE RESERVED IN THE EVENT OF THE GRANT OF A PATENT OF A UTILITY MODEL OR DESIGN.

PROJECT: AMF0006847_02.sch
FILE NAME
TYPE:

REVISIONS	01	02								DATE	16/12/2014				
LAST REVISION DATE	16/12/2014							COMMISS.	O.Maggiolaro						
SHEET STATUS	0							CHECK.							
SABIK VERSION	Ver. 18.00							APPROV.		SUBST.:		SUB. FOR:		ORIGIN:	

X1

MORSETTIERA POTENZA

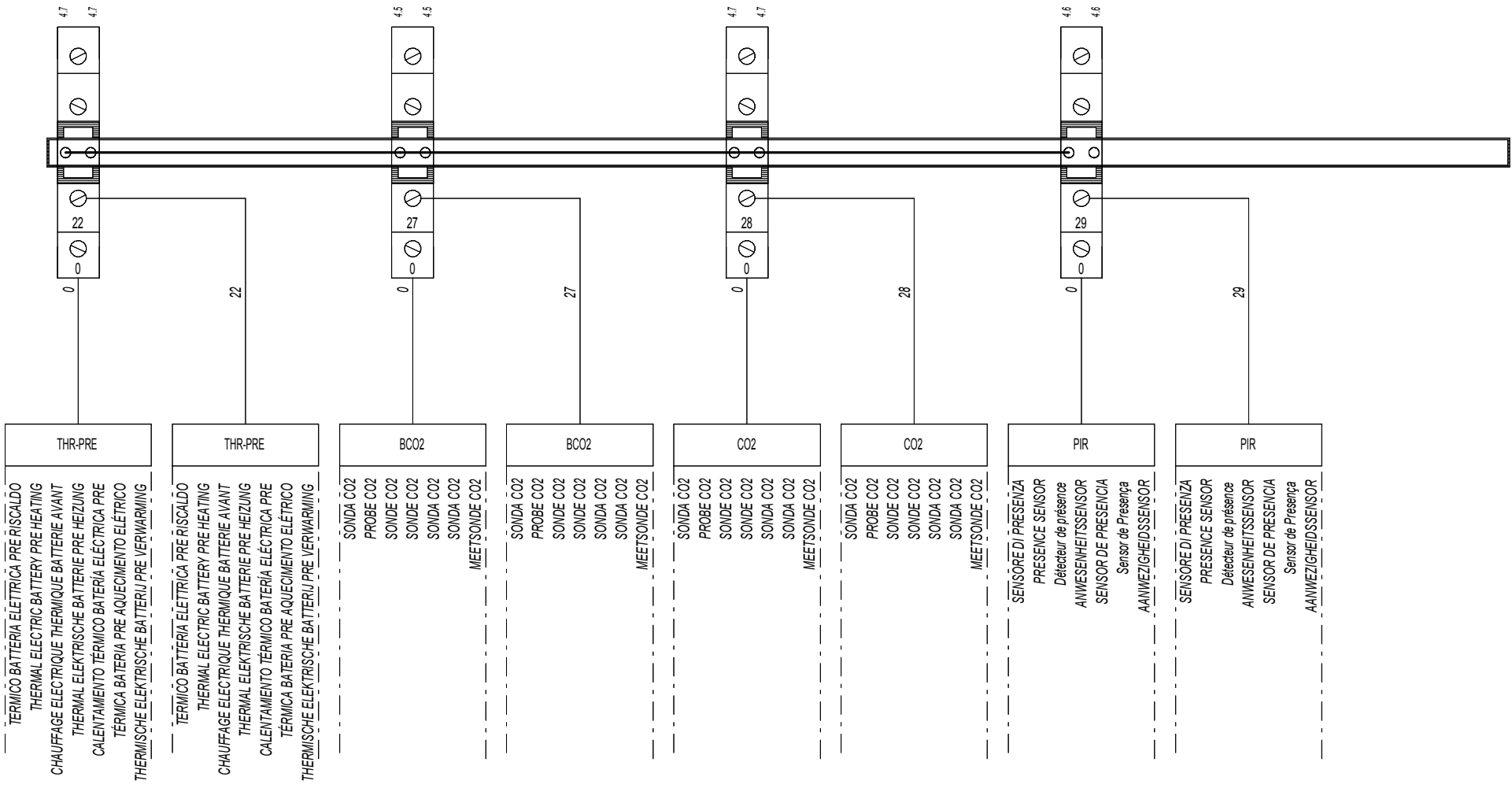

THR-PRE
 TERMICO BATTERIA ELETTRICA PRE RISCALDO
 THERMAL ELECTRIC BATTERY PRE HEATING
 CHAUFFAGE ELECTRIQUE THERMIQUE BATTERIE AVANT
 THERMAL ELEKTRISCHE BATTERIE PRE HEIZUNG
 CALENTAMIENTO TÉRMICO BATERÍA ELÉCTRICA PRE
 TÉRMICA BATERIA PRE AQUECIMENTO ELÉTRICO
 THERMISCHE ELEKTRISCHE BATTERIJ PRE VERWARMING

THR-PRE
 TERMICO BATTERIA ELETTRICA PRE RISCALDO
 THERMAL ELECTRIC BATTERY PRE HEATING
 CHAUFFAGE ELECTRIQUE THERMIQUE BATTERIE AVANT
 THERMAL ELEKTRISCHE BATTERIE PRE HEIZUNG
 CALENTAMIENTO TÉRMICO BATERÍA ELÉCTRICA PRE
 TÉRMICA BATERIA PRE AQUECIMENTO ELÉTRICO
 THERMISCHE ELEKTRISCHE BATTERIJ PRE VERWARMING

BCO2
 SONDA CO2
 PROBE CO2
 SONDÉ CO2
 SONDÉ CO2
 SONDÉ CO2
 SONDÉ CO2
 SONDÉ CO2
 MEETSONDÉ CO2

BCO2
 SONDA CO2
 PROBE CO2
 SONDÉ CO2
 SONDÉ CO2
 SONDÉ CO2
 SONDÉ CO2
 SONDÉ CO2
 MEETSONDÉ CO2

CO2
 SONDA CO2
 PROBE CO2
 SONDÉ CO2
 SONDÉ CO2
 SONDÉ CO2
 SONDÉ CO2
 MEETSONDÉ CO2

CO2
 SONDA CO2
 PROBE CO2
 SONDÉ CO2
 SONDÉ CO2
 SONDÉ CO2
 SONDÉ CO2
 MEETSONDÉ CO2

PIR
 SENSORE DI PRESENZA
 PRESENCE SENSOR
 Détecteur de présence
 ANWESENHEITSSENSOR
 SENSOR DE PRESENCIA
 Sensor de Presença
 AANWEZIGHEIDSSENSOR

PIR
 SENSORE DI PRESENZA
 PRESENCE SENSOR
 Détecteur de présence
 ANWESENHEITSSENSOR
 SENSOR DE PRESENCIA
 Sensor de Presença
 AANWEZIGHEIDSSENSOR

RIEPILOGO MORSETTI

COPYING OF THIS DOCUMENT, AND GIVING IT TO OTHERS AND THE USE OR COMMUNICATION OF THE CONTENTS THEREOF, ARE FORBIDDEN WITHOUT EXPRESS AUTHORITY. OFFENDERS ARE LIABLE TO THE PAYMENT OF DAMAGES. ALL RIGHTS ARE RESERVED IN THE EVENT OF THE GRANT OF A PATENT OF THE REGISTRATION OF A UTILITY MODEL OR DESIGN.

PROJECT: AMF0006847_02.sct
FILE NAME
TYPE:

REVISIONS	01	02								DATE	16/12/2014
LAST REVISION DATE	16/12/2014								COMMISS.	O.Meggiolaro	
SHEET STATUS	0								CHECK.		
SABIK VERSION	Ver. 18.00								APPROV.		

MORSETTIERA POTENZA X1

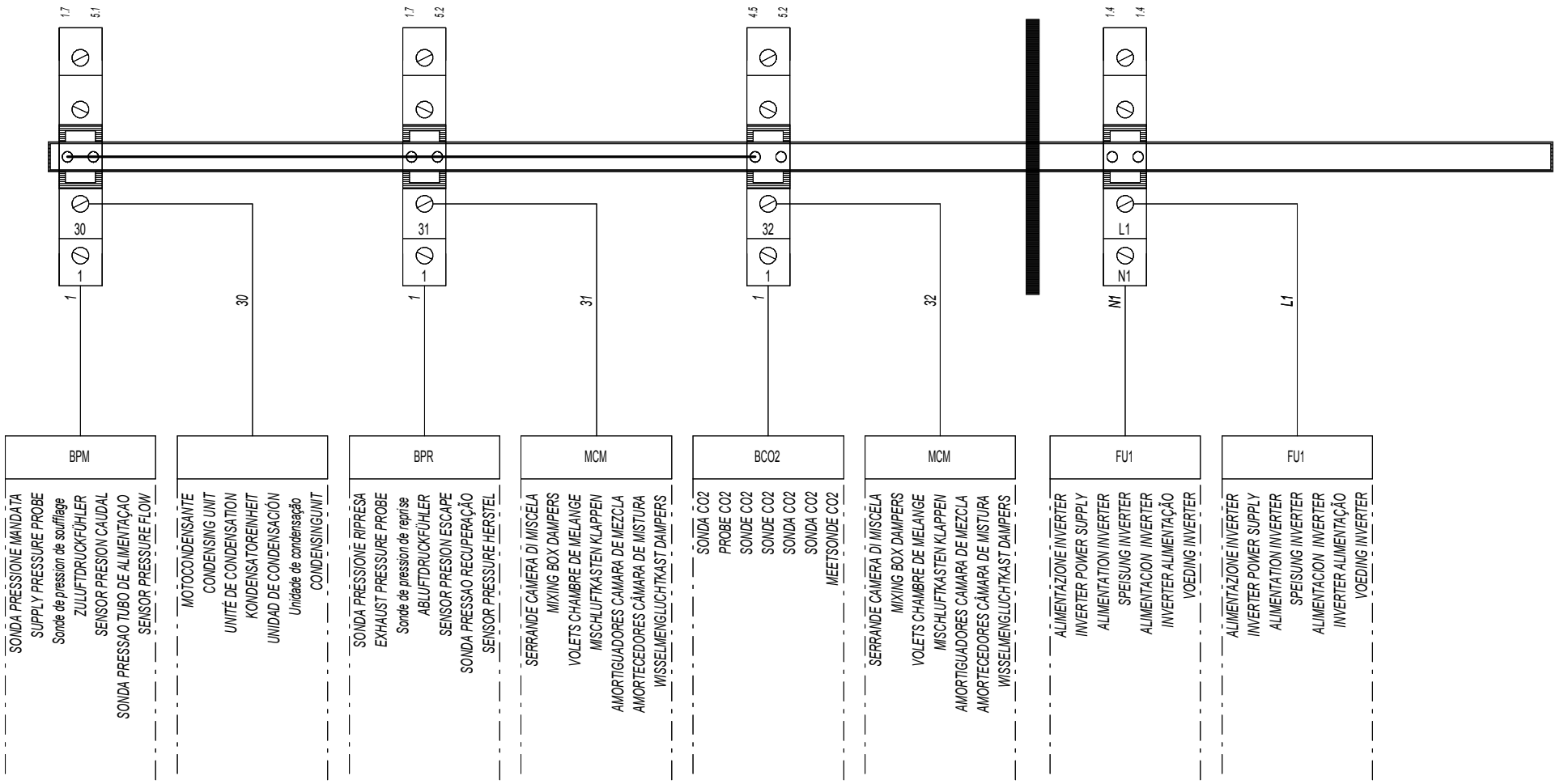

RIEPILOGO MORSETTI

AMF0006847	RKE30-RKH30-RKS3V40	SHEET 13
		14 N.S.

COPYING OF THIS DOCUMENT, AND GIVING IT TO OTHERS AND THE USE OR COMMUNICATION OF THE CONTENTS THEREOF, ARE FORBIDDEN WITHOUT EXPRESS AUTHORITY. OFFENDERS ARE LIABLE TO THE PAYMENT OF DAMAGES. ALL RIGHTS ARE RESERVED IN THE EVENT OF THE GRANT OF A PATENT OF THE REGISTRATION OF A UTILITY MODEL OR DESIGN.

PROJECT: AMF0006847_02.scp
FILE NAME
TYPE:

REVISIONS	01	02								DATE	16/12/2014
LAST REVISION DATE	16/12/2014								COMMISS.	O.Meggiolaro	
SHEET STATUS	0								CHECK.		
SABIK VERSION	Ver. 18.00								APPROV.		

MORSETTIERA POTENZA X1

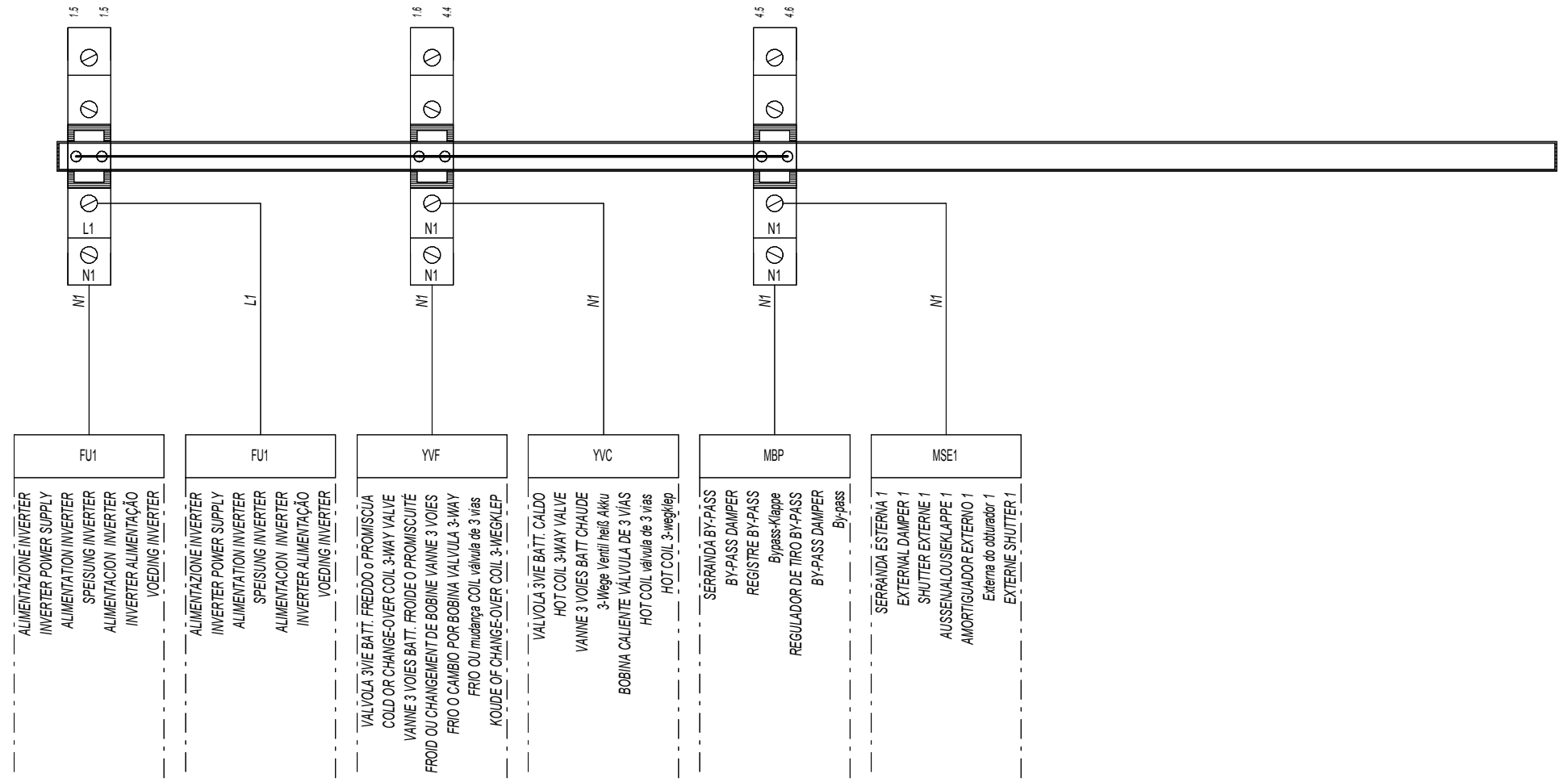

FU1
ALIMENTAZIONE INVERTER
INVERTER POWER SUPPLY
ALIMENTATION INVERTER
SPEISUNG INVERTER
ALIMENTACION INVERTER
INVERTER ALIMENTAÇÃO
VOEDING INVERTER

FU1
ALIMENTAZIONE INVERTER
INVERTER POWER SUPPLY
ALIMENTATION INVERTER
SPEISUNG INVERTER
ALIMENTACION INVERTER
INVERTER ALIMENTAÇÃO
VOEDING INVERTER

YVF
VALVOLA 3VIE BATT. FREDDO o PROMISCUA
COLD OR CHANGE-OVER COIL 3-WAY VALVE
VANNE 3 VOIES BATT. FROIDE O PROMISCUITE
FROID OU CHANGEMENT DE BOBINE VANNE 3 VOIES
FRIO O CAMBIO POR BOBINA VALVULA 3-WAY
FRIO OU mudança COIL válvula de 3 vias
KOUDE OF CHANGE-OVER COIL 3-WEGKLEP

YVC
VALVOLA 3VIE BATT. CALDO
HOT COIL 3-WAY VALVE
VANNE 3 VOIES BATT CHAUDE
3-Wege Ventil heiß Akku
BOBINA CALENTE VALVULA DE 3 VIAS
HOT COIL válvula de 3 vias
HOT COIL 3-wegklep

MBP
SERRANDA BY-PASS
BY-PASS DAMPER
REGISTRE BY-PASS
Bypass-Klappe
REGULADOR DE TIRO BY-PASS
BY-PASS DAMPER
By-pass

MSE1
SERRANDA ESTERNA 1
EXTERNAL DAMPER 1
SHUTTER EXTERNE 1
AUSSENJALOUSIEKLAPPE 1
AMORTIGUADOR EXTERNO 1
Externa do obturador 1
EXTERNE SHUTTER 1

										RIEPILOGO MORSETTI					
												AMF0006847		RKE30-RKH30-RKS3V40	
														SHEET 14	
														15 N.S.	

COPYING OF THIS DOCUMENT, AND GIVING IT TO OTHERS AND THE USE OR COMMUNICATION OF THE CONTENTS THEREOF, ARE FORBIDDEN WITHOUT EXPRESS AUTHORITY. OFFENDERS ARE LIABLE TO THE PAYMENT OF DAMAGES. ALL RIGHTS ARE RESERVED IN THE EVENT OF THE GRANT OF A PATENT OF THE REGISTRATION OF A UTILITY MODEL OR DESIGN.

PROJECT: AMF0006847_02.sch
 FILE NAME
 TYPE:

REVISIONS	01	02								DATE	16/12/2014
LAST REVISION DATE	16/12/2014								COMMISS.	O.Meggiolaro	
SHEET STATUS	0								CHECK.		
SABIK VERSION	Ver. 18.00								APPROV.		

X3

MORSETTIERA AUSILIARI

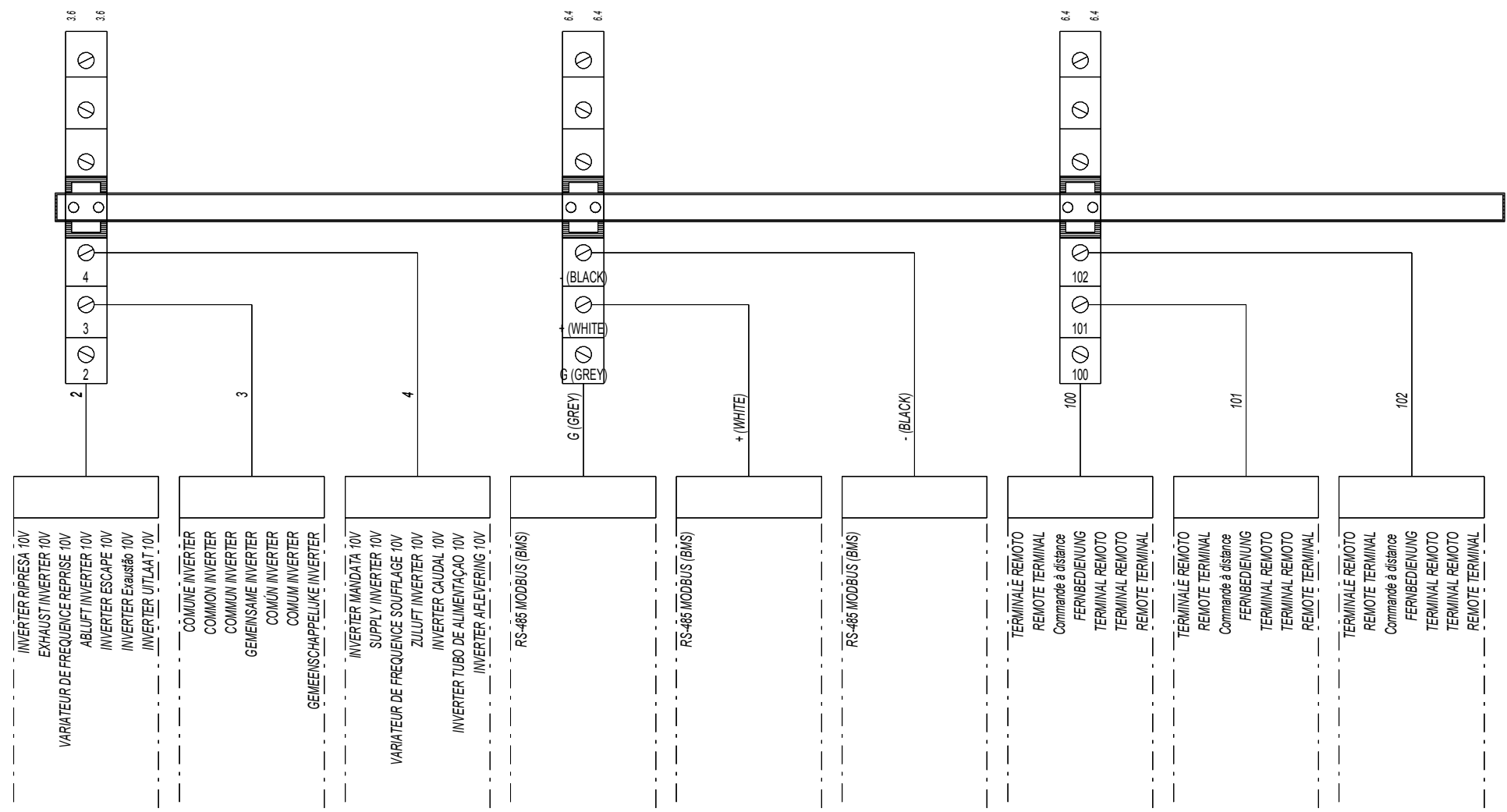

INVERTER RIPRESA 10V
 EXHAUST INVERTER 10V
 VARIATEUR DE FREQUENCE REPRISE 10V
 ABLUFT INVERTER 10V
 INVERTER ESCAPE 10V
 INVERTER Exaustão 10V
 INVERTER UITLAAT 10V

COMUNE INVERTER
 COMMON INVERTER
 COMMUN INVERTER
 GEMEINSAME INVERTER
 COMUN INVERTER
 COMUM INVERTER
 GEMEENSCHAPPELIJKE INVERTER

INVERTER MANDATA 10V
 SUPPLY INVERTER 10V
 ZULUFT INVERTER 10V
 INVERTER CAUDAL 10V
 INVERTER TUBO DE ALIMENTAÇÃO 10V
 INVERTER AFEVERING 10V

RS-485 MODBUS (BMS)

RS-485 MODBUS (BMS)

RS-485 MODBUS (BMS)

TERMINALE REMOTO
 REMOTE TERMINAL
 Commande à distance
 FERNBEDIENUNG
 TERMINAL REMOTO
 TERMINAL REMOTO
 REMOTE TERMINAL

TERMINALE REMOTO
 REMOTE TERMINAL
 Commande à distance
 FERNBEDIENUNG
 TERMINAL REMOTO
 TERMINAL REMOTO
 REMOTE TERMINAL

TERMINALE REMOTO
 REMOTE TERMINAL
 Commande à distance
 FERNBEDIENUNG
 TERMINAL REMOTO
 TERMINAL REMOTO
 REMOTE TERMINAL

RIEPILOGO MORSETTI

1 2 3 4 5 6 7 8

A

B

C

D

E

A

B

C

D

E

COMPONENTE DESIGNATION	ARTICOLO ARTICLE	DESCRIZIONE ARTICOLO ITEM DESCRIPTION	DESCRIZIONE COMPONENTE DESCRIPTION COMPONENT	CONSTRUTTORE MANUFACTURER	CODICE CODE
A1			TRIAC MANDATA TRIAC SUPPLY TRIAC REFOULEMENT TRIAC FORDERLEISTUNG TRIAC CAUDAL TRIAC TUBO DE ALIMENTAÇÃO TRIAC AFLEVERING		
A2			TRIAC RIPRESA TRIAC EXHAUST TRIAC REPRISE TRIAC ABLUFT TRIAC ESCAPE TRIAC Exaustão TRIAC UITLAAT		
AI			ALLARME ANTINCENDIO FIRE ALARM ALARM ANTI-INCENDE FEUERALARM ALARMA DE INCENDIO ALARME DE INCÊNDIO BRANDALARM		
BCO2			SONDA CO2 PROBE CO2 SONDE CO2 SONDE CO2 SONDA CO2 SONDA CO2 MEETSONDE CO2		
BPM			SONDA PRESSIONE MANDATA SUPPLY PRESSURE PROBE Sonde de pression de soufflage ZULUFTDRUCKFÜHLER SENSOR PRESION CAUDAL SONDA PRESSAO TUBO DE ALIMENTAÇÃO SENSOR PRESSURE FLOW		
BPR			SONDA PRESSIONE RIPRESA EXHAUST PRESSURE PROBE Sonde de pression de reprise ABLUFTDRUCKFÜHLER SENSOR PRESION ESCAPE SONDA PRESSAO RECUPERAÇÃO SENSOR PRESSURE HERSTEL		

COPYING OF THIS DOCUMENT, AND GIVING IT TO OTHERS AND THE USE OR COMMUNICATION OF THE CONTENTS THEREOF, ARE FORBIDDEN WITHOUT EXPRESS AUTHORITY. OFFENDERS ARE LIABLE TO THE PAYMENT OF DAMAGES. ALL RIGHTS ARE RESERVED IN THE EVENT OF THE GRANT OF A PATENT OF THE REGISTRATION OF A UTILITY MODEL OR DESIGN.

PROJECT: AMF0006847_02.sch
 FILE NAME
 TYPE:

REVISIONS	01									DATE	10/04/2014							
LAST REVISION DATE	10/04/2014		COMMISS.	OM	DISTINTA CON TRADUZIONE-PART LIST													
SHEET STATUS	0		CHECK.															
SABIK VERSION	Ver. 18.00		APPROV.		SUBST.:		SUB. FOR:		ORIGIN:			AMF0006847	RKE30-RKH30-RKS3V40			SHEET	DB-001	
	1															DB-002	N.S.	

1 2 3 4 5 6 7 8

1 2 3 4 5 6 7 8

A

B

C

D

E

F

A

B

C

D

E

F

COPYING OF THIS DOCUMENT, AND GIVING IT TO OTHERS AND THE USE OR COMMUNICATION OF THE CONTENTS THEREOF, ARE FORBIDDEN WITHOUT EXPRESS AUTHORITY. OFFENDERS ARE LIABLE TO THE PAYMENT OF DAMAGES. ALL RIGHTS ARE RESERVED IN THE EVENT OF THE GRANT OF A PATENT OF THE REGISTRATION OF A UTILITY MODEL OR DESIGN.

PROJECT: AMF0006847_02.scp
 FILE NAME
 TYPE:

COMPONENTE DESIGNATION	ARTICOLO ARTICLE	DESCRIZIONE ARTICOLO ITEM DESCRIPTION	DESCRIZIONE COMPONENTE DESCRIPTION COMPONENT	COSTRUTTORE MANUFACTURER	CODICE CODE
BTA			SONDA TEMPERATURA ANTIGELO ANTI-FREEZE TEMPERATURE PROBE SONDE TEMPERATURE ANTIGEL ANTI-FROST TEMPERATUR SENSOR SONDA DE TEMPERATURA DE FROST TEMPERATURA PROBE DE FROST TEMPERATUURSONDE FROST		
BTE			SONDA TEMPERATURA ESTERNA FRESH AIR TEMPERATURE SENSOR CAPTEUR DE TEMPÉRATURE AIR NEUF EXTERNER TEMPERATURSENSOR AIRE FRESCO DEL SENSOR DE TEMPERATURA SENSOR DE TEMPERATURA DO AR FRESCO VERSE LUCHT TEMPERATUURSENSOR		
BTES			SONDA TEMPERATURA ESPULSIONE EXHAUST TEMPERATURE PROBE SONDE DE TEMPERATUE EN EXPULSION Ablufttemperatur Sensor SENSOR DE TEMPERATURA EXPULSION EXPULSAO SENSOR DE TEMPERATURA UITLAAT TEMPERATUURSENSOR		
BTM			SONDA TEMPERATURA MANDATA SUPPLY AIR TEMPERATURE SENSOR CAPTEUR DE TEMPÉRATURE SOUFFLAGE ZULUFT TEMPERATUR SENSOR TEMPERATURA SENSOR DE FLUJO FORNECIMENTO SENSOR TEMPERATURA DO AR Inblaas temperatuuropmeter		
FU1	3NW7053	1 PORTA FUSIBILE 10X38 1P+N	FUSIBILE FUSE FUSIBLE ABSCHMELZS. FUSIBLE FUSIVEL ZEKERING	SIEMENS	3NW7053
1		FUSIBILE CILINDRICO 10x38 500V 12A	FUSIBILE FUSE FUSIBLE ABSCHMELZS. FUSIBLE FUSIVEL ZEKERING	SIEMENS	3NW8006-1

REVISIONS	01									DATE	10/04/2014				=
LAST REVISION DATE	10/04/2014		COMMISS.	OM								DISTINTA CON TRADUZIONE-PART LIST			+
SHEET STATUS	0		CHECK.									AMF0006847		RKE30-RKH30-RKS3V40	SHEET DB-002
SABIK VERSION	Ver. 18.00		APPROV.			SUBST.:	SUB. FOR:		ORIGIN:					DB-003	N.S.

1 2 3 4 5 6 7 8

1 2 3 4 5 6 7 8

A

B

C

D

E

F

A

B

C

D

E

F

PROJECT: AMF0006847_02.sch
 FILE NAME
 TYPE:
 COPYING OF THIS DOCUMENT, AND GIVING IT TO OTHERS AND THE USE OR COMMUNICATION OF THE CONTENTS THEREOF, ARE FORBIDDEN WITHOUT EXPRESS AUTHORITY. OFFENDERS ARE LIABLE TO THE PAYMENT OF DAMAGES. ALL RIGHTS ARE RESERVED IN THE EVENT OF THE GRANT OF A PATENT OF THE REGISTRATION OF A UTILITY MODEL OR DESIGN.

COMPONENTE DESIGNATION	ARTICOLO ARTICLE	DESCRIZIONE ARTICOLO ITEM DESCRIPTION	DESCRIZIONE COMPONENTE DESCRIPTION COMPONENT	CONSTRUTTORE MANUFACTURER	CODICE CODE
GD1		ALIMENTATORE DR-15-24 100-240VAC/24VDC/0.63	ALIMENTATORE C.C. D.C. POWER SUPPLY ALIMENTATION C.C. GLEICHSTROMSPEISER ALIMENTADOR C.C. ALIMENTADOR C.C. VOEDING GELIJKSTROOM	MEAN WELL	DR-15-24
KAL		MINI RELÉ 1 CONTATTI IN SCAMBIO 12VDC 8A	RELE' ALLARME GENERALE GENERAL ALARM RELAY RELAIS ALARME GÉNÉRALE ALLGEMEINALARM- RELAY ALARMA GENERAL RELE ALARME GERAL RELÉ ALGEMEEN ALARM RELAY	SCHNEIDER	RSL1AB4JD
1		ZOCCOLO RELÉ ELETTRMECCANICO 12V AC/DC 1 SCAMBIO	RELE' ALLARME GENERALE GENERAL ALARM RELAY RELAIS ALARME GÉNÉRALE ALLGEMEINALARM- RELAY ALARMA GENERAL RELE ALARME GERAL RELÉ ALGEMEEN ALARM RELAY	SCHNEIDER	RSLZRA1
KAMO		MINI RELÉ 1 CONTATTI IN SCAMBIO 12VDC 8A	RELE' CAMBIO MODO ESTATE INVERNO RELAY CHANGE MODE SUMMER WINTER RELAY HIVER ÉTÉ CHANGEMENT DE MODE RELAY Änderungsmodus sommer winter RELE MODO CAMBIO DE VERANO INVIERNO RELÉ MUDANÇA DE INVERNO VERÃO MODO RELAY CHANGE MODE ZOMER WINTER	SCHNEIDER	RSL1AB4JD
1		ZOCCOLO RELÉ ELETTRMECCANICO 12V AC/DC 1 SCAMBIO	RELE' CAMBIO MODO ESTATE INVERNO RELAY CHANGE MODE SUMMER WINTER RELAY HIVER ÉTÉ CHANGEMENT DE MODE RELAY Änderungsmodus sommer winter RELE MODO CAMBIO DE VERANO INVIERNO RELÉ MUDANÇA DE INVERNO VERÃO MODO RELAY CHANGE MODE ZOMER WINTER	SCHNEIDER	RSLZRA1
KAPC		MINI RELÉ 1 CONTATTI IN SCAMBIO 12VDC 8A	RELE' POMPA CALDA RELAY PUMP HOT POMPE RELAIS HOT RELAY heiß Pumpe RELE DE LA BOMBA CALIENTE RELE DE LA BOMBA QUENTE RELAY PUMP HOT	SCHNEIDER	RSL1AB4JD

REVISIONS	01	DATE	10/04/2014	DISTINTA CON TRADUZIONE-PART LIST		=	
LAST REVISION DATE	10/04/2014	COMMISS.	OM			+	
SHEET STATUS	0	CHECK.				AMF0006847	RKE30-RKH30-RKS3V40
SABIK VERSION	Ver. 18.00	APPROV.		SUBST.:	SUB. FOR:	ORIGIN:	
1	2	3	4	5	6	7	8

SHEET DB-003
DB-004 N.S.

A
B
C
D
E
F

COMPONENTE DESIGNATION	ARTICOLO ARTICLE	DESCRIZIONE ARTICOLO ITEM DESCRIPTION	DESCRIZIONE COMPONENTE DESCRIPTION COMPONENT	COSTRUTTORE MANUFACTURER	CODICE CODE
1		ZOCCOLO RELÈ ELETTRMECCANICO 12V AC/DC 1 SCAMBIO	RELE' POMPA CALDA RELAY PUMP HOT POMPE RELAIS HOT RELAY heiß Pumpe RELE DE LA BOMBA CALIENTE RELE DE LA BOMBA QUENTE RELAY PUMP HOT	SCHNEIDER	RSLZRA1
KAPF		MINI RELÈ 1 CONTATTI IN SCAMBIO 12VDC 8A	RELE' POMPA FREDDA O PROMISCUA RELAY PUMP COLD OR CHANGE-OVER POMPE RELAIS FROID OU PROMISCUITÉ RELAY kalt Pumpe oder promiskuitiv BOMBA DE RELE NEGATIVO O PROMISCUO BOMBA RELÉ 'FRIO OU PROMÍSCUA RELAY POMP KOUD OF PROMISCUE	SCHNEIDER	RSL1AB4JD
1		ZOCCOLO RELÈ ELETTRMECCANICO 12V AC/DC 1 SCAMBIO	RELE' POMPA FREDDA O PROMISCUA RELAY PUMP COLD OR CHANGE-OVER POMPE RELAIS FROID OU PROMISCUITÉ RELAY kalt Pumpe oder promiskuitiv BOMBA DE RELE NEGATIVO O PROMISCUO BOMBA RELÉ 'FRIO OU PROMÍSCUA RELAY POMP KOUD OF PROMISCUE	SCHNEIDER	RSLZRA1
KAU		MINI RELÈ 1 CONTATTI IN SCAMBIO 12VDC 8A	RELÉ RAFFREDDAMENTO ADIABATICO RELAY COOLING ADIABATIC RELAIS REFROIDISSEMENT ADIABATIQUE ADIABATISCHE KÜHLUNG RELAY RELÉ ENFRIAMIENTO ADIABÁTICO Rele de arrefecimento adiabático RELAY KOELING ADIABATISCHE	SCHNEIDER	RSL1AB4JD
1		ZOCCOLO RELÈ ELETTRMECCANICO 12V AC/DC 1 SCAMBIO	RELÉ RAFFREDDAMENTO ADIABATICO RELAY COOLING ADIABATIC RELAIS REFROIDISSEMENT ADIABATIQUE ADIABATISCHE KÜHLUNG RELAY RELÉ ENFRIAMIENTO ADIABÁTICO Rele de arrefecimento adiabático RELAY KOELING ADIABATISCHE	SCHNEIDER	RSLZRA1
MBP			SERRANDA BY-PASS BY-PASS DAMPER REGISTRE BY-PASS Bypass-Klappe REGULADOR DE TIRO BY-PASS BY-PASS DAMPER By-pass		

COPYING OF THIS DOCUMENT, AND GIVING IT TO OTHERS AND THE USE OR COMMUNICATION OF THE CONTENTS THEREOF, ARE FORBIDDEN WITHOUT EXPRESS AUTHORITY. OFFENDERS ARE LIABLE TO THE PAYMENT OF DAMAGES. ALL RIGHTS ARE RESERVED IN THE EVENT OF THE GRANT OF A PATENT OF A UTILITY MODEL OR DESIGN.

PROJECT: AMF0006847_02.sch
FILE NAME
TYPE:

REVISIONS	01									DATE	10/04/2014				=
LAST REVISION DATE	10/04/2014		COMMISS.	OM								DISTINTA CON TRADUZIONE-PART LIST			+
SHEET STATUS	0		CHECK.									AMF0006847	RKE30-RKH30-RKS3V40	SHEET DB-004	
SABIK VERSION	Ver. 18.00		APPROV.			SUBST.:	SUB. FOR:	ORIGIN:							DB-005 N.S.

1

2

3

4

5

6

7

8

A

A

COMPONENTE DESIGNATION	ARTICOLO ARTICLE	DESCRIZIONE ARTICOLO ITEM DESCRIPTION	DESCRIZIONE COMPONENTE DESCRIPTION COMPONENT	CONSTRUTTORE MANUFACTURER	CODICE CODE
MCM			SERRANDE CAMERA DI MISCELA MIXING BOX DAMPERS VOLETS CHAMBRE DE MELANGE MISCHLUFTKASTEN KLAPPEN AMORTIGUADORES CAMARA DE MEZCLA AMORTECEDORES CÂMARA DE MISTURA WISSELMENGLUCHTKAST DAMPERS		
MSE1			SERRANDA ESTERNA 1 EXTERNAL DAMPER 1 SHUTTER EXTERNE 1 AUSSENJALOUSIEKLAPPE 1 AMORTIGUADOR EXTERNO 1 Externa do obturador 1 EXTERNE SHUTTER 1		
MSE2			SERRANDA ESTERNA 1 EXTERNAL DAMPER 1 SHUTTER EXTERNE 1 AUSSENJALOUSIEKLAPPE 1 AMORTIGUADOR EXTERNO 1 Externa do obturador 1 EXTERNE SHUTTER 1		
PSTD			PRESSOSTATO FILTRI FILTERS PRESSURE SWITCH PRESSOSTAT FILTRES FILTER DRUCKSCHALTER FILTROS DE PRESOSTATO FILTROS PRESSOSTATO FILTERS DRUKSCHAKELAAR		
SH1			UMIDOSTATO HUMIDISTAT HUMIDISTAT HUMIDISTAT HUMIDISTATO UMIDOSTATO HUMIDISTAAT		
THR-POST			TERMICO BATTERIA ELETTRICA POST RISCALDO THERMAL BATTERY ELECTRIC HEATING POST THERMIQUE POST CHAUFFAGE ELECTRIQUE BATTERIE THERMAL BATTERY ELEKTROHEIZUNG POST BATERIA TÉRMICO POSTERIOR CALEFACCIÓN ELÉCTRICA TÉRMICA BATERIA POST AQUECIMIENTO ELÉTRICO THERMISCHE BATTERIJ ELEKTRISCHE VERWARMING POST		

B

B

C

C

D

D

E

E

F

F

COPYING OF THIS DOCUMENT, AND GIVING IT TO OTHERS AND THE USE OR COMMUNICATION
 OF THE CONTENTS THEREOF, ARE FORBIDDEN WITHOUT EXPRESS AUTHORITY. OFFENDERS
 ARE LIABLE TO THE PAYMENT OF DAMAGES. ALL RIGHTS ARE RESERVED IN THE EVENT
 OF THE GRANT OF A PATENT OF THE REGISTRATION OF A UTILITY MODEL OR DESIGN.

PROJECT: AMF0006847_02.sct
 FILE NAME
 TYPE:

REVISIONS	01										DATE	10/04/2014
LAST REVISION DATE	10/04/2014		COMMISS.	OM								
SHEET STATUS	0		CHECK.									
SABIK VERSION	Ver. 18.00		APPROV.									

SUBST.:			SUB. FOR:			ORIGIN:					
---------	--	--	-----------	--	--	---------	--	--	--	--	--

DISTINTA CON TRADUZIONE-PART LIST

AMF0006847

RKE30-RKH30-RKS3V40

SHEET DB-005

DB-006 N.S.

1

2

3

4

5

6

7

8

1 2 3 4 5 6 7 8

A

B

C

D

E

F

A

B

C

D

E

F

COPYING OF THIS DOCUMENT, AND GIVING IT TO OTHERS AND THE USE OR COMMUNICATION OF THE CONTENTS THEREOF, ARE FORBIDDEN WITHOUT EXPRESS AUTHORITY. OFFENDERS ARE LIABLE TO THE PAYMENT OF DAMAGES. ALL RIGHTS ARE RESERVED IN THE EVENT OF THE GRANT OF A PATENT OF A UTILITY MODEL OR DESIGN.

PROJECT: AMF0006847_02.sch
FILE NAME:
TYPE:

COMPONENTE DESIGNATION	ARTICOLO ARTICLE	DESCRIZIONE ARTICOLO ITEM DESCRIPTION	DESCRIZIONE COMPONENTE DESCRIPTION COMPONENT	COSTRUTTORE MANUFACTURER	CODICE CODE
THR-PRE			TERMICO BATTERIA ELETTRICA PRE RISCALDO THERMAL ELECTRIC BATTERY PRE HEATING CHAUFFAGE ELECTRIQUE THERMIQUE BATTERIE AVANT THERMAL ELEKTRISCHE BATTERIE PRE HEIZUNG CALENTAMIENTO TÉRMICO BATERÍA ELÉCTRICA PRE TÉRMICA BATERIA PRE AQUECIMENTO ELÉTRICO THERMISCHE ELEKTRISCHE BATTERIJ PRE VERWARMING		
YVC			VALVOLA 3VIE BATT. CALDO HOT COIL 3-WAY VALVE VANNE 3 VOIES BATT CHAUDE 3-Wege Ventil heiß Akku BOBINA CALIENTE VÁLVULA DE 3 VÍAS HOT COIL válvula de 3 vías HOT COIL 3-wegklep		
YVF			VALVOLA 3VIE BATT. FREDDO o PROMISCUA COLD OR CHANGE-OVER COIL 3-WAY VALVE VANNE 3 VOIES BATT. FROIDE O PROMISCUITÉ FROID OU CHANGEMENT DE BOBINE VANNE 3 VOIES FRIO O CAMBIO POR BOBINA VALVULA 3-WAY FRIO OU mudança COIL válvula de 3 vías KOUDE OF CHANGE-OVER COIL 3-WEGKLEP		
YVU			VALVOLA UMIDIFICAZIONE VALVE HUMIDIFICATION SOUPAPE HUMIDIFICATION VENTIL ANFEUCHTEN VALVULA HUMECTACION VÁLVULA HUMIDIFICAÇÃO KLEP BEVOCHTIGING		

REVISIONS	01												DATE	10/04/2014					=		
LAST REVISION DATE	10/04/2014			COMMISS.	OM													+			
SHEET STATUS	0			CHECK.																	
SABIK VERSION	Ver. 18.00			APPROV.		SUBST.:		SUB. FOR:		ORIGIN:								AMF0006847	RKE30-RKH30-RKS3V40	SHEET DB-006	N.S.

1 2 3 4 5 6 7 8